

**EPSON® PowerLite® 51c/71c
Multimedia Projector**

User's Guide

Important Safety Information

WARNING: Never look into the projector lens when the lamp is turned on; the bright light can damage your eyes. Never let children look into the lens when it is on. Never open any cover on the projector, except the lamp and filter covers. Dangerous electrical voltages inside the projector can severely injure you. Except as specifically explained in this *User's Guide*, do not attempt to service this product yourself. Refer all servicing to qualified service personnel.

WARNING: The projector and its accessories come packaged in plastic bags. Keep plastic bags away from small children to avoid any risk of suffocation.

Caution: When you replace the lamp, never touch the new lamp with your bare hands; the invisible residue left by the oil on your hands may shorten the lamp life. Use a cloth or glove to handle the new lamp.

Copyright Notice

All rights reserved. No part of this publication may be reproduced, stored in a retrieval system, or transmitted in any form or by any means, electronic, mechanical, photocopying, recording, or otherwise, without the prior written permission of SEIKO EPSON CORPORATION. The information contained herein is designed only for use with this EPSON product. EPSON is not responsible for any use of this information as applied to other products.

Neither SEIKO EPSON CORPORATION nor its affiliates shall be liable to the purchaser of this product or third parties for damages, losses, costs, or expenses incurred by purchaser or third parties as a result of: accident, misuse, or abuse of this product or unauthorized modifications, repairs, or alterations to this product, or (excluding the U.S.) failure to strictly comply with SEIKO EPSON CORPORATION's operating and maintenance instructions.

SEIKO EPSON CORPORATION shall not be liable for any damages or problems arising from the use of any options or any consumable products other than those designated as Original EPSON Products or EPSON Approved Products by SEIKO EPSON CORPORATION.

EPSON is a registered trademark of SEIKO EPSON CORPORATION.

PowerLite and Presenters Club are registered trademarks; SizeWise is a trademark; and EPSON Store, EPSON PrivateLine, and Extra Care are service marks of Epson America, Inc.

General Notice: Other product names used herein are for identification purposes only and may be trademarks of their respective owners. EPSON disclaims any and all rights in those marks.

Contents

Welcome

| | |
|-------------------------------------|---|
| Using Your Documentation | 2 |
| Reading This Manual Online. | 2 |
| Getting More Information. | 3 |
| Registration and Warranty | 4 |

1 *Setting Up the Projector*

| | |
|--|----|
| Unpacking the Projector. | 5 |
| Additional Components. | 6 |
| Optional Accessories | 6 |
| Positioning the Projector | 7 |
| Choosing Your Connections. | 9 |
| Connecting to a Computer. | 10 |
| Connecting to a PC Laptop | 10 |
| Connecting to a PC Desktop Computer | 12 |
| Connecting to a PowerBook | 14 |
| Connecting to a Macintosh Desktop Computer. | 16 |
| Connecting to Video Sources | 18 |
| Connecting the RCA A/V Video Cable | 18 |
| Connecting an S-Video Cable | 19 |
| Connecting a Component Video Cable | 19 |
| Connecting to External Speakers or a PA System | 21 |

2 *Using the Projector*

| | |
|---|----|
| Turning On Your Equipment. | 23 |
| What To Do If You See a Blank Screen | 25 |
| Adjusting Your Image. | 29 |
| Focusing Your Image | 29 |
| Adjusting the Image Size | 29 |
| Adjusting the Image Height. | 30 |
| Adjusting the Image Shape. | 31 |
| Adjusting the Image Quality | 32 |
| Using the Remote Control | 32 |
| Installing the Remote Control Batteries | 32 |
| Operating the Projector with the Remote Control | 33 |
| Using the Remote Control as a Wireless Mouse | 34 |

| | |
|---|----|
| Controlling Audio and Video | 35 |
| Switching Between Picture Sources | 35 |
| Freezing the Picture | 35 |
| Turning Off the Picture and Sound | 36 |
| Adjusting Sound Volume | 36 |
| Highlighting Your Presentation | 36 |
| Using the Cursor/Stamp Arrow | 37 |
| Drawing a Horizontal Bar | 37 |
| Shutting Down the Projector | 38 |

3 *Fine-Tuning the Projector*

| | |
|--|----|
| Using the Menus | 39 |
| Changing Menu Settings | 40 |
| Adjusting the Image | 41 |
| Adjusting the Sound | 43 |
| Customizing the Highlighting Tools | 43 |
| Customizing Projector Features | 44 |
| Viewing Projector Information | 45 |
| Restoring the Default Settings | 46 |

4 *Maintaining and Transporting the Projector*

| | |
|--|----|
| Cleaning the Lens | 48 |
| Cleaning the Projector Case | 48 |
| Cleaning the Air Intake Vent | 49 |
| Replacing the Lamp | 50 |
| Transporting the Projector | 52 |

5 *Solving Problems*

| | |
|--|----|
| Using the On-Screen Help | 53 |
| Checking the Projector's Lights | 55 |
| Image or Sound Problems | 56 |
| Problems with the Remote Control | 59 |
| Where To Get Help | 60 |

6 *Technical Specifications*

| | |
|--|----|
| General | 63 |
| Projection Lamp | 64 |
| Remote Control | 64 |
| Mouse Compatibility | 64 |
| Dimensions | 64 |
| Electrical | 64 |
| Environmental | 64 |
| Safety | 65 |
| Computer Connector Pin Assignments | 65 |
| Compatible Video Formats | 66 |

7 *Notices*

| | |
|---|----|
| Important Safety Instructions | 69 |
| Remote Control Information | 71 |
| Declaration of Conformity | 72 |
| FCC Compliance Statement | 73 |
| Warranty | 74 |

Index

W *Welcome*

Your EPSON® PowerLite® 51c or PowerLite 71c is a small, lightweight, affordable projector offering powerful 3-LCD performance and easy-to-use controls. Your projector weighs less than 7 pounds and displays full-color images at a resolution of up to 800 × 600 pixels (EPSON PowerLite 51c) or 1024 × 768 pixels (EPSON PowerLite 71c).

Producing up to 1000 ANSI lumens (EPSON PowerLite 71c) or 1200 ANSI lumens (EPSON PowerLite 51c), your projector creates bright images that can be easily seen in rooms light enough to take notes.

You can connect it simultaneously to two image sources: a computer and a video device, such as a VCR, DVD player, laser disc player, camcorder, or digital camera. You can also connect audio for each image source.

You can operate your projector through a hand-held remote control, with buttons for zooming in on your image, adjusting volume, and accessing all the projector's features. You can also use the remote control as a wireless mouse, and run your presentation as you move around the room.

EPSON's SizeWise™ technology supports a range of computer outputs, for a full-size image from just about any notebook PC or PowerBook.® If you use a VCR or other video source, the projector automatically senses the video format, so you can use it with confidence no matter where in the world you travel.

The EPSON® PrivateLineSM Technical Support program will get you help when you need it. A special 800 number and your own PIN will connect you with a projector support specialist—fast.

Using Your Documentation

To connect the projector to your laptop and get your presentation running fast, see the *Quick Setup* sheet that came in your *Owner's Kit*.

This book contains all the information you need to set up and use your projector. Please follow these guidelines as you read through it:

- Warnings must be followed carefully to avoid bodily injury.
- Cautions must be observed to avoid damage to your equipment.
- Notes contain important information about your projector.

warning

caution

note

Reading This Manual Online

Your EPSON PowerLite CD-ROM includes an electronic copy of this manual. You may find it convenient to copy it onto your laptop's hard drive so it's always with you—for example, when taking your presentation on the road.

To view your electronic manual, you need to use Adobe® Acrobat® Reader. Just insert the CD-ROM in your drive and do one of the following:

Windows: Select the **Install/View User's Guide** button and click **Install User's Guide** or **View User's Guide**.

Macintosh: Double-click the  **Projector** icon. Click the **Install/View User's Guide** button, then click **Install User's Guide** or **View User's Guide**.

When you open the manual, you see this toolbar:

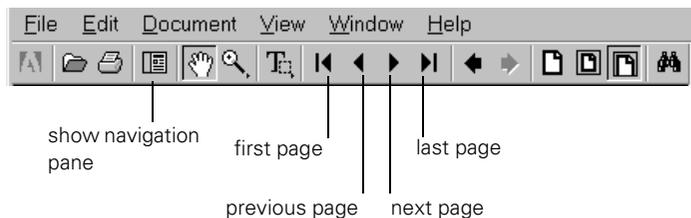

You have several ways to navigate through the manual:

- Click in the table of contents on the left side of the screen to move quickly to the topic of your choice.
- Use the arrow buttons in the toolbar or on the vertical scroll bar on the right side of the screen to move through the manual.
- If you hold your mouse pointer over text and the hand changes to an index finger, you can click to jump to a related topic.

For more information, see your Acrobat Reader online guide.

Getting More Information

Need more tips on giving presentations? How about quick steps for setting up your projector? Here's where you can look for help:

- **www.presentersonline.com**
Includes a library of articles covering presentation tips, tricks, and technology. The site provides templates, clip art and sound clips, as well as Presenters Services to use on the road. Even more resources and services are available if you register to join the Presenters Club®—and it's free.
- ***Quick Setup* sheet**
Gives you all the instructions you need to get your projector set up and connected to a laptop or PowerBook computer.
- ***Owner's Kit***
Includes your *Quick Setup* sheet, international warranty, EPSON Extra CareSM Two Year Road Service, CD-ROMs, and EPSON PrivateLine Support card. Store this *User's Guide* in the folder and keep the folder with your projector at all times.
- **Built-in help system**
Provides assistance for common problems. Available from the Help button on the projector or the remote control. See page 53 for details.

note

You don't need to install any software to use your projector.

- support.epson.com
Download FAQs and e-mail your questions to EPSON support.
- **CD-ROM**
Your *Owner's Kit* includes the EPSON PowerLite CD-ROM that lets you register electronically, and includes the electronic copy of this book as well as a link to *Presenters Online*.

If you still need help after checking this *User's Guide* and the sources listed above, you can use the EPSON PrivateLine Support service to get help fast. Call (800) 637-7661 and enter the PIN on the card in your *Owner's Kit*. Or take advantage of EPSON's automated support services 24 hours a day. See page 60 for more information.

Registration and Warranty

Your projector comes with a basic carry-in warranty as well as an international warranty that let you project with confidence anywhere in the world. For details about the carry-in warranty, see page 74. For more information about the international warranty, see the warranty brochure included in your *Owner's Kit*.

In addition, for customers who register their projector, EPSON offers free Extra Care Road Service. In the unlikely event of an equipment failure, you won't have to wait for your unit to be repaired. Instead, EPSON will ship you a replacement unit anywhere in the United States or Canada, usually via overnight delivery. See the brochure in your *Owner's Kit* for details.

To register, simply insert the EPSON PowerLite CD-ROM that came with your projector and select **Register Online**. Registering also lets you receive special updates on new accessories, products, and services. You can register through the Internet, by e-mail or 800-number modem connection, or by printing out the form to fax or mail.

1 *Setting Up the Projector*

This chapter tells you how to unpack your projector and set it up for a presentation. The projector must be connected to a computer or a video source such as a DVD player, VCR, camcorder, digital camera, or other video device before it can project images.

To set up the projector, you need to:

- Unpack and position the projector
- Connect the projector to one or more input sources

Unpacking the Projector

Make sure you have all the parts shown:

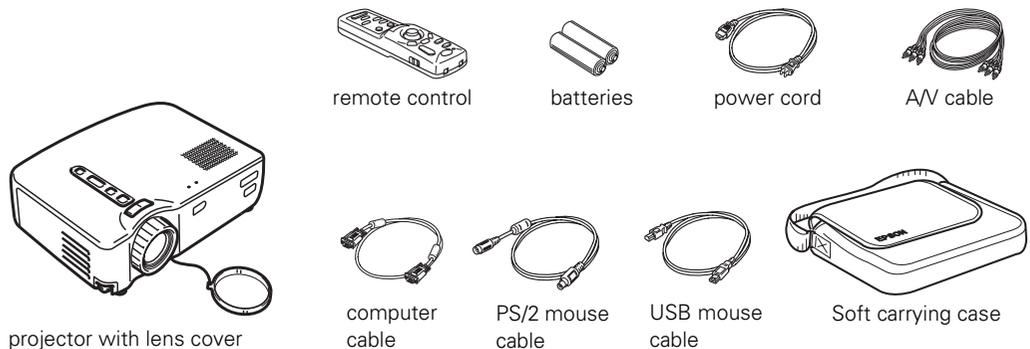

note

You won't need all these components; your configuration will determine which ones you need.

Save all packaging in case you need to ship the projector. Always use the original packaging (or the equivalent) when you need to send the projector to another location. If you are moving the projector by hand, use a carrying case (either an EPSON case or something similar, such as a laptop case). See page 52 for transportation instructions.

Additional Components

Depending on how you use the projector, you may need these additional components:

- To receive an S-Video signal, you need an S-Video cable (usually provided with your video device).
- Older iMac™ systems may need a special adapter to provide a VGA output port; see your computer dealer.
- To project HDTV images, you'll need an HDTV cable, available from most electronics dealers.
- To receive an audio signal, you'll need a stereo mini-jack cable, available from most electronics dealers.

Optional Accessories

To enhance your use of the projector, EPSON provides the following optional accessories:

| Product | Product number |
|--|--|
| Customized carrying cases: ATA molded hard shell carrying case ATA shipping case Samsonite® wheeled soft case Notebook/Projector soft shoulder bag | ELPKS36 ELPKS37 ELPKS24 ELPKS13 |
| Replacement lamp | V13H010L16 |
| Ceiling mount Suspension adapter False ceiling plate | ELPMB35 ELPMBAPL ELPMBFCP |
| Projection screens: 50-inch portable screen 60-inch Insta Theatre screen 80-inch Insta Theatre screen | ELPSC06 ELPSC07 ELPSC08 |
| Component video cable | ELPKC19 |
| Macintosh adapter set | ELPAP01 |
| Kensington security lock | ELPSL01 |
| Presentation audio system | ELPPAS1 |
| Wireless microphone system | ELPCVSII |

| Product | Product number |
|---|--------------------|
| Distribution amplifier | ELPDA01 |
| Document cameras High resolution document imager Motion presentation camera | ELPDC02 ELPDC03 |

You can purchase these accessories from your dealer, or by calling EPSON at (800) 873-7766, or by visiting the EPSON StoreSM at www.epsonstore.com (U.S. sales only). In Canada, please call (800) 463-7766 for dealer referral.

Positioning the Projector

The location in which you choose to set up your projector depends on the size of the room and your presentation style.

- Place the projector on a sturdy, level surface, within this distance from the screen:
 - 3.3 to 36 feet in Wide mode
 - 3.9 to 43.2 feet in Tele mode
 - (see page 29 for more information on these modes)
- Make sure there is plenty of space for ventilation around and under the projector.
- Make sure the projector is within 6 feet of a grounded electrical outlet or extension cord, and within 5 feet of your computer and/or video source.
- Place the projector directly in front of the center of the screen, facing it toward the screen squarely. Otherwise, your image will not be square.

Most presenters find it convenient to place the screen in the front of the room with the projector back near the front of the audience, leaving ample room between the screen and projector to get a good-sized image. Then the presenter can stand in front of the room, facing the audience and control the equipment from there.

note

It's best to position the screen directly in front of the room. If it's placed diagonally in a corner, it's much more difficult to aim the projector at the screen correctly and get a square image.

Use the figure below as a guideline to help you determine how far from the screen to place the projector. Your image size may not exactly match these sizes; its actual size depends on whether you have adjusted the image size setting (using keystone correction or the **Wide/Tele** button).

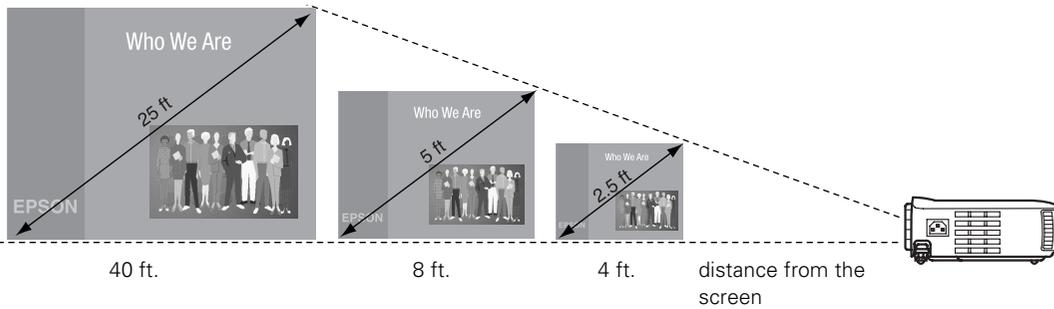

When projecting from a table, the ideal arrangement is to set the projector flat on its surface with the base of the lens at about the level of the bottom of the screen. This delivers the best-looking picture.

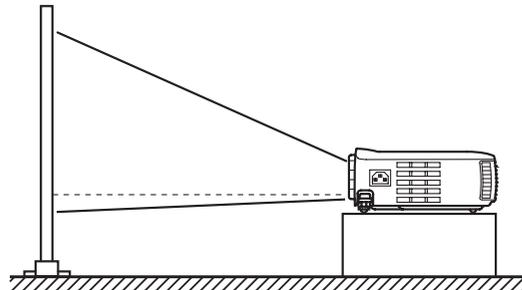

If you have to raise the projector by adjusting its feet (described on page 30), you'll need to square-up the sides of the image by pressing the **Keystone** button (see page 31).

If you'll be projecting from overhead, you'll get the best-looking picture by mounting the projector upside-down, parallel to the ceiling, with the bottom of the lens level with the top of the screen. (You'll also need to select ceiling projection mode in the projector's Advanced menu; see page 44.)

Choosing Your Connections

The connections you'll need to make depend on the equipment you're using, whether your presentation includes sound, and whether you plan to use the remote to run your presentation.

- **Connecting to a computer or laptop**

For many presentations, the only connection you'll need is between your computer and the projector; see page 10.

- **Connecting to video sources**

You can connect the projector to a DVD player, VCR, camcorder, laser disc player, digital camera, or another type of video source. You can even connect a video source and computer at the same time and switch between the two; see page 18.

- **Using the remote control**

You can use the remote control to switch between input sources, zoom into your image, and control other projector features.

To use the remote control as a wireless mouse, you'll need to connect one of the projector mouse cables. Then you can click through your presentation from up to 32 feet away. See page 32 for instructions on using the remote control.

- **Including sound in your presentation**

If your presentation includes sound, you can connect an audio cable to use the projector's built-in speaker. See the instructions for your input source in "Connecting to a Computer" on page 10 and/or "Connecting to Video Sources" on page 18.

If you need more volume, you can also connect the projector to external speakers or a public address system; see page 21.

Connecting to a Computer

Follow the instructions in these sections for the type of computer you need to connect:

- “Connecting to a PC Laptop” below
- “Connecting to a PC Desktop Computer” on page 12
- “Connecting to a PowerBook” on page 14
- “Connecting to a Macintosh Desktop Computer” on page 16

Connecting to a PC Laptop

To connect the projector to your laptop, notebook computer, or hand-held device, you need to use the computer cable. If you’ll be using the remote control as a wireless mouse, you need to connect a mouse cable. If you’ll be using audio through the projector’s speakers, you need to connect an audio cable (not included with the projector).

Connecting the Computer Cable

Before you start, turn off your laptop and the projector.

1. Connect one end of the computer cable to the projector’s Computer port.

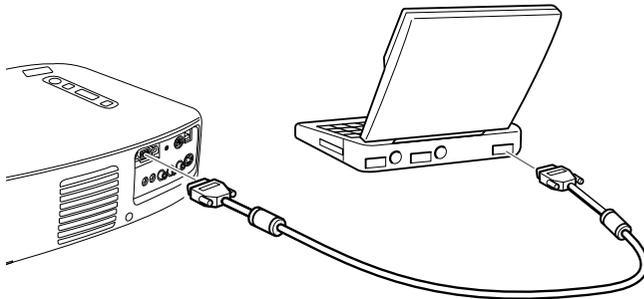

note

Laptop configurations vary. See your manual if you're not familiar with the ports on your laptop.

2. Connect the other end of the cable to your laptop’s video-out or monitor port.
3. Tighten the screws on the connectors.

If you don’t need to make any other connections, you can plug in and turn on your equipment; see page 23 for instructions.

Connecting the Mouse Cable

To use the remote control as a wireless mouse, you need to connect a mouse cable: either the round PS/2 or the flat USB mouse cable.

1. Connect one end of the appropriate mouse cable to the PS/2 Mouse/Com port or the  USB Mouse port on the projector.

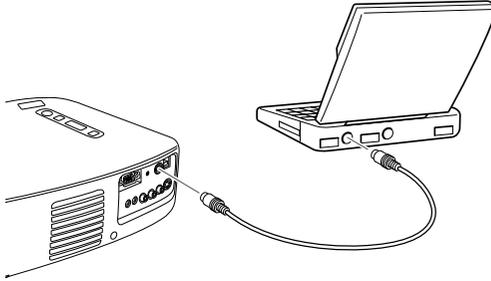

2. Connect the other end to your laptop's external mouse or USB port.
3. If necessary, configure your laptop to work with an external mouse.

If you don't need to make any other connections, you can plug in and turn on your equipment; see page 23 for instructions.

Connecting the Audio Cable

If you'll be using audio through your projector's speakers, you need to connect a stereo, mini-jack audio cable (not included).

1. Connect one end of the audio cable to the Audio In port on the projector.

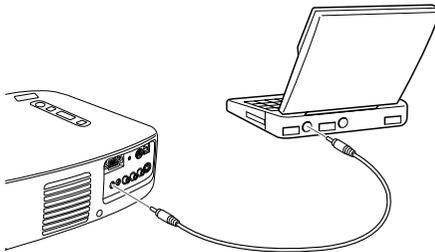

2. Connect the other end to the laptop's headphone or audio out jack.

note

See page 34 for instructions on using the remote control as a wireless mouse.

You can use the USB port for a mouse only on systems configured originally with Windows® 98, Me, 2000, or XP. If you upgraded your system from Windows 3.1 or 95, the USB port may not work as a mouse port.

note

If you need additional volume (in a large auditorium, for example), you can also connect external speakers or a public address system to the projector. See page 21 for instructions.

If you don't need to make any other connections, you can plug in and turn on your equipment; see page 23 for instructions.

Connecting to a PC Desktop Computer

To connect the projector to your PC desktop computer, you need to use the computer cable. If you'll be using the remote control as a wireless mouse, you need to connect a mouse cable. If you'll be using audio through the projector's speakers, you need to connect an audio cable (not included with the projector).

Connecting the Computer Cables

Before you start, turn off your projector and computer.

1. Disconnect the monitor cable from the monitor port on the back of your computer.
2. Connect one end of the computer cable to the projector's Computer port.

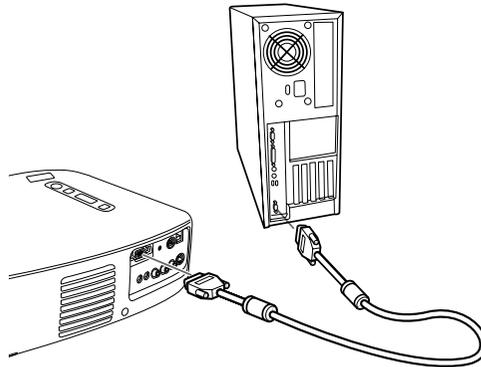

3. Connect the other end of the computer cable to your computer's video (monitor) port.
4. Tighten the screws on the connectors.

If you don't need to make any other connections, you can plug in and turn on your equipment; see page 23 for instructions.

Connecting the Mouse Cable

To use the remote control as a wireless mouse, you need to connect a mouse cable: either the round PS/2 or the flat USB mouse cable.

1. Connect one end of the appropriate mouse cable to the PS/2 Mouse/Com port or the  USB Mouse port on the projector.

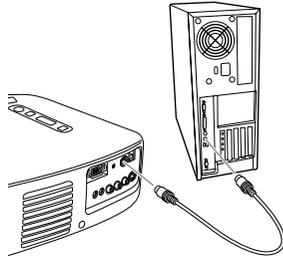

2. Connect the other end to the mouse port on your computer.
3. Tighten the screws on the connectors.

If you don't need to make any other connections, you can plug in and turn on your equipment; see page 23 for instructions.

Connecting the Audio Cable

If you'll be using audio through your projector's speakers, you need to connect a stereo, mini-jack audio cable (not included).

1. Connect one end of the audio cable to the Audio In port on the projector.

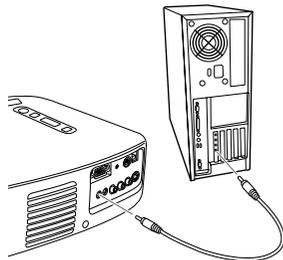

2. Connect the other end of the audio cable to the speaker or audio out port on the computer's sound card. If you don't need to make any other connections, you can plug in and turn on your equipment; see page 23 for instructions.

note

See page 34 for instructions on using the remote control as a wireless mouse.

You can use the USB port for a mouse only on systems configured originally with Windows 98, Me, 2000, or XP. If you upgraded your system from Windows 3.1 or 95, the USB port may not work as a mouse port.

note

If you need additional volume (in a large auditorium, for example), you can also connect external speakers or a public address system; see page 21 for instructions.

Connecting to a PowerBook

You can connect your projector to most PowerBooks that support an external monitor. To connect the projector to your PowerBook, you need to use the computer cable. If you'll be using the remote control as a wireless mouse, you need to connect a mouse cable. If you'll be using audio through the projector's speakers, you need to connect an audio cable (not included with the projector).

Connecting the Computer Cable

Before you start, turn off your PowerBook and the projector.

1. Connect one end of the computer cable to the projector's **Computer** port.
2. Connect the other end to your PowerBook's  monitor port.

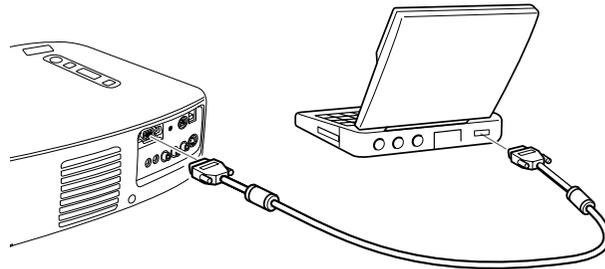

3. Tighten the screws on the connectors.

If you don't need to make any other connections, you can plug in and turn on your equipment; see page 23 for instructions.

Connecting the Mouse Cable

To use the remote control as a wireless mouse, you need to connect the USB mouse cable.

1. Connect one end of the USB mouse cable to the  USB Mouse port on the projector.

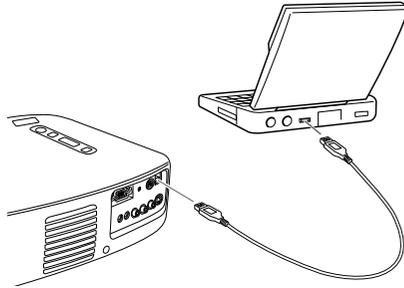

2. Connect the other end to the USB port on your PowerBook.

If you don't need to make any other connections, you can plug in and turn on your equipment; see page 23 for instructions.

Connecting the Audio Cable

If you'll be using audio through your projector's speakers, you'll need to connect a stereo, mini-jack audio cable (not included).

1. Connect one end of the audio cable to the **Audio In** port on the projector.

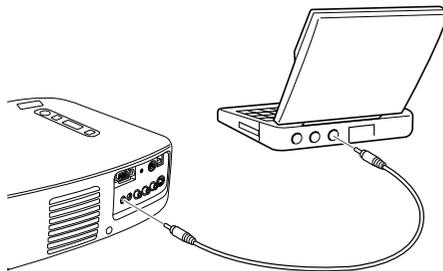

2. Connect the other end to the audio out port on your PowerBook.

If you don't need to make any other connections, you can plug in and turn on your equipment; see page 23 for instructions.

note

Your Macintosh must be using Macintosh OS 8.51 or later for USB support.

See page 34 for instructions on using the remote control as a wireless mouse.

note

If you need additional volume (in a large auditorium, for example), you can also connect external speakers or a public address system; see page 21 for instructions.

Connecting to a Macintosh Desktop Computer

To connect the projector to your desktop Macintosh, you need to use the computer cable. If you'll be using the remote control as a wireless mouse, you need to connect a mouse cable. If you'll be using audio through the projector's speakers, you need to connect an audio cable.

Connecting the Computer Cable

Before you start, turn off the projector and computer.

1. Disconnect the monitor cable from the video (monitor) port on the back of the Macintosh.
2. Connect one end of the computer cable to the projector's Computer port.

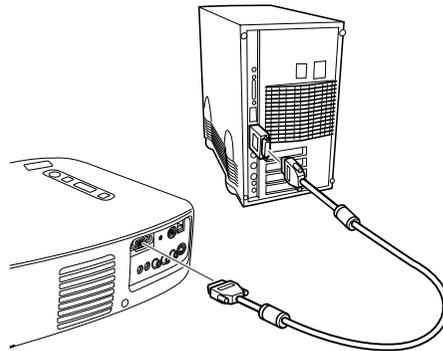

3. Connect the other end of the computer cable to the video (monitor) port on the Macintosh.
4. Tighten the screws on the connectors.

If you don't need to make any other connections, you can plug in and turn on your equipment; see page 23 for instructions.

Connecting the Mouse Cable

To use the remote control as a wireless mouse, you need to connect the USB mouse cable.

1. Connect one end of the USB mouse cable to the  USB Mouse port on the projector.

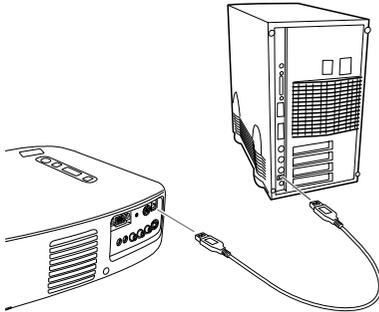

2. Connect the other end to the USB port on your Macintosh.

If you don't need to make any other connections, you can plug in and turn on your equipment; see page 23 for instructions.

Connecting the Audio Cable

If you'll be using audio through your projector's speakers, you'll need to connect a stereo, mini-jack audio cable (not included).

1. Connect one end of the audio cable to the Audio In port on the projector.

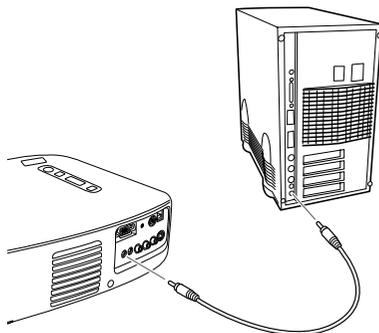

2. Connect the other end of the audio cable to the audio-out port on your Macintosh.

note

Your Macintosh must be using Macintosh OS 8.51 or later for USB support.

See page 34 for instructions on using the remote control as a wireless mouse.

note

If you need additional volume (in a large auditorium, for example), you can also connect external speakers or a public address system; see page 21 for instructions.

If you don't need to make any other connections, you can plug in and turn on your equipment; see page 23 for instructions.

note

You can't use the projector with a cable TV-style F connector.

Connecting to Video Sources

You can connect a DVD player, VCR, camcorder, laser disc player, digital camera, or any other compatible video source to your projector. You can connect one video source and a computer at the same time, and easily switch between them. The projector supports HDTV, NTSC, PAL, and SECAM formats, and automatically detects the one you're using.

Connecting the RCA A/V Video Cable

Before you start, make sure the projector and your VCR or other video source are turned off.

1. Connect the yellow plug on one end of the A/V cable to the projector's yellow **Video** jack.
2. Connect the other yellow plug to the video-out jack on your video source.
3. Connect the red and white plugs on the A/V cable to the projector's **Audio L** (white) and **R** (red) jacks.

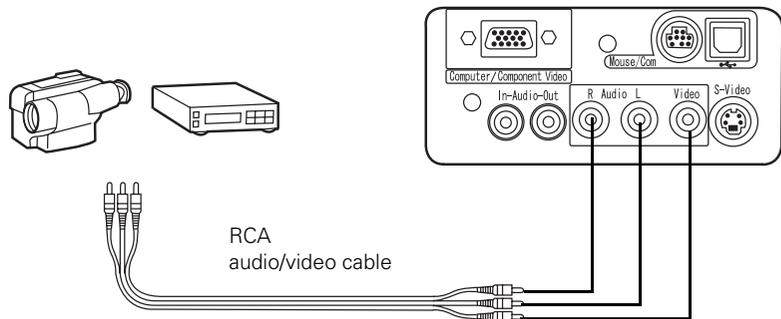

4. Connect the red and white plugs at the other end of the cable to the corresponding audio output jacks on your video source.

Connecting an S-Video Cable

If your video source has an S-Video jack (as shown with an S-Video plug to the right), you can use it to project a higher quality video image. However, you'll need an S-Video cable, which may be included with your video source or may be purchased from an electronics or video store.

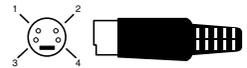

Before you start, make sure the projector and your VCR or other video source are turned off.

1. Insert one end of the S-Video cable into the projector's S-Video connector.

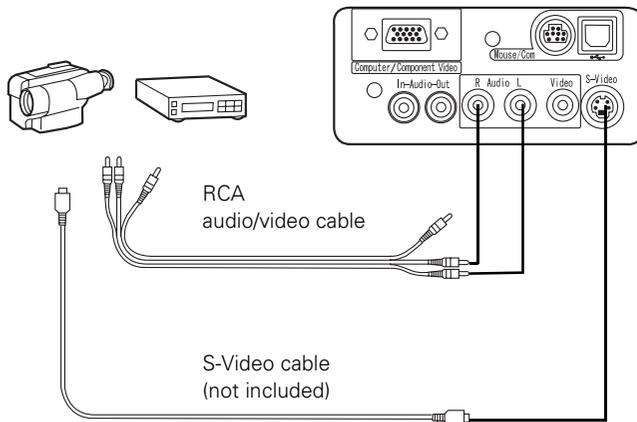

2. Insert the other end into the S-Video output port of your video source.
3. Connect the red and white plugs on the A/V cable to the projector's Audio L (white) and R (red) jacks.
4. Connect the red and white plugs at the other end of the cable to the corresponding audio output jacks on your video source.

Connecting a Component Video Cable

You can connect a component video cable to project images from a DVD player or HDTV video source. You'll need the RCA A/V cable (included with your projector) and a component video cable (optional; available from EPSON as described on page 6).

Before you start, make sure the projector and your component video source are turned off.

1. Connect the red and white plugs on the A/V cable to the projector's Audio L (white) and R (red) jacks.

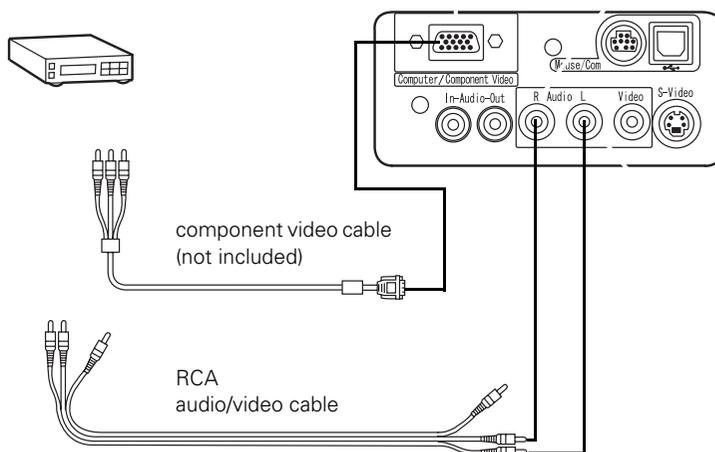

2. Connect the red and white plugs at the other end of the A/V cable to the corresponding audio output jacks on your video source.
3. Connect the 15-pin connector on the component video cable to the projector's computer port.
4. Connect the green, blue, and red jacks on the other end of the cable to these ports on your component video source:
 - Y (green)
 - Pb or Cb (blue)
 - Pr or Cr (red) port.
5. Select the correct settings for your component video source in the projector's Video menu (as described on page 42):
 - If you connected the projector to a DVD player, select YCbCr as the Input Signal setting.
 - If you connected an HDTV source or if your DVD player supports YPbPr, select YPbPr as the Input Signal setting.

note

If your projected image seems distorted, you may need to change your aspect ratio. Generally, 16.9 (for wide screen) is the correct setting.

Connecting to External Speakers or a PA System

The projector's speaker is loud enough for most small- or medium-size rooms. For large rooms or maximum volume, you can connect the projector to external speakers or a public address (PA) system.

You'll need an RCA-to-3.5 mm stereo audio cable, which may be included with your sound system or may be purchased from an electronics store.

Before you start, make sure the projector and speakers or PA system are turned off.

1. Connect the cable's 3.5 mm stereo miniplug to the projector's Audio Out jack.

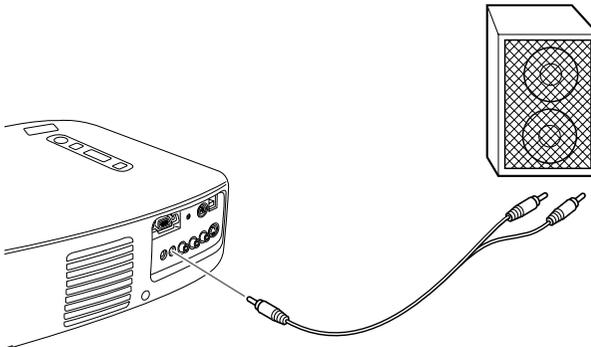

2. Connect the RCA plugs to the speaker or PA system. Insert the cable's red plug into the Audio R jack and the white plug into the Audio L jack.

note

The projector's internal speaker is disabled when you use an external audio system.

2

Using the Projector

Once you've connected the projector to your computer or other equipment (as described in Chapter 1), you're ready to turn on the projector, adjust the image, and give your presentation. This chapter covers the following:

- Turning on the projector and other equipment
- Adjusting your image
- Using the remote control
- Controlling audio and video
- Highlighting your presentation
- Shutting down the projector and other equipment

Turning On Your Equipment

Make sure your projector and other equipment are set up and connected correctly, as described in Chapter 1. Then plug in and turn on your equipment, as described below.

note

If you have more than one source connected, you may have to switch to the one you want to use, as described on page 25.

Follow these steps to plug in and turn on your equipment:

1. If you're projecting video, first plug in and turn on your VCR, DVD player, or other video source. (If you're projecting from a computer, go to step 2.)
2. To turn on the projector, first connect one end of the power cord to the projector's power inlet on its left side.

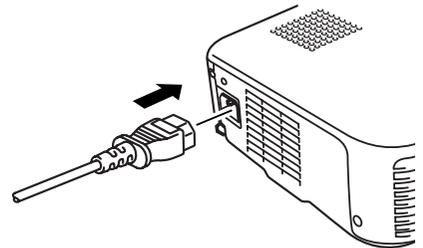

warning

Never look into the lens when the lamp is on. This can damage your eyes, and is especially dangerous for children.

note

Windows only: If you see a New Hardware Found message saying that Windows has found a plug-and-play monitor, click Cancel.

3. Connect the other end to a grounded electrical outlet.

The **⏻ Power** light on the projector turns orange, indicating that the projector is receiving power and is in sleep mode, but is not yet turned on.

4. Remove the lens cap.

5. Press the red **⏻ Power** button on top of the projector. (You can also turn on the projector using the remote control, but you must turn on the remote control first; see page 32.)

The **⏻ Power** light flashes green and then stays on. You see a blue screen with the message **No Signal** displayed.

6. If you're projecting images from a computer, turn on your computer. In a few moments, you should see your computer display projected. (If a projected image fails to appear, see the next section for help.)

7. If you're projecting video, press the **Play** button. (If a projected image fails to appear, see the next section for help.)

Once you see your image, turn to page 29 for instructions on focusing and making other image adjustments.

When you're done with your presentation, shut down the projector as described on page 38. Shutting down the projector correctly prevents premature lamp failure and possible damage to the projector from overheating.

What To Do If You See a Blank Screen

If you see a blank screen or a blue screen with the message **No Signal** after turning on your computer or video source, do one of the following:

- Make sure the cables are connected correctly, as described in Chapter 1.
- Make sure the  Power light is green and not flashing and the lens cap is off.
- If you've connected more than one input source, you may need to press the **Source** button on top of the projector or the **Computer**, **Video**, or **S-Video** button on the remote control to select the source you want to use. (Allow a few seconds for the projector to sync up after pressing the button.)

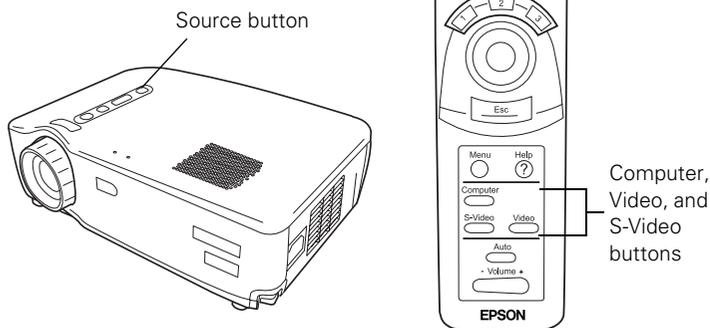

- Try restarting your computer.
- If you still don't see an image and you're using a PowerBook, see page 26 or 27 for additional steps. If you're using a PC laptop, see page 28.

If You're Using a PowerBook Running OS 9.x or Earlier. . .

You may need to set up your system to display on the projector screen as well as the LCD screen. Follow these steps:

1. From the Apple menu, select **Control Panels**, then click **Monitors and Sound**.
2. Click the **Arrange** icon.

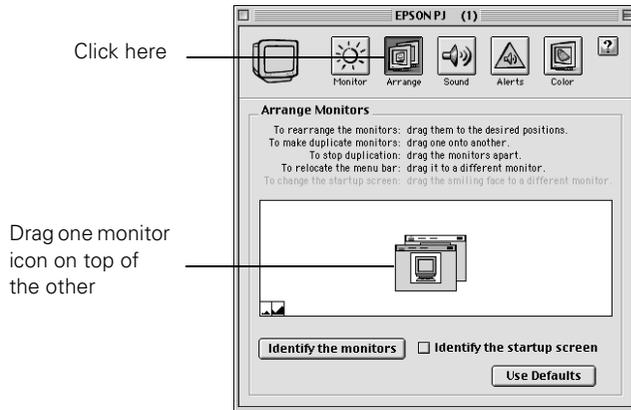

3. Drag one monitor icon on top of the other.

If this option isn't available, you may need to select one of the Simulscan resolution settings. Click the **MONITOR** icon, then select a **Simulscan** resolution as shown. (Allow a few seconds for the projector to sync up after making the selection.)

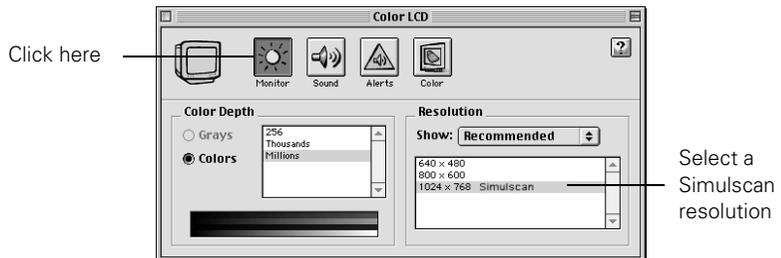

If You're Using a PowerBook Running OS X . . .

You may need to set up your system to display on the projector as well as the LCD screen. Follow these steps:

1. Select **System Preferences** from the Apple menu.
2. Click **Displays**.
3. Click **Detect Displays** to display part of your desktop on the projector screen.

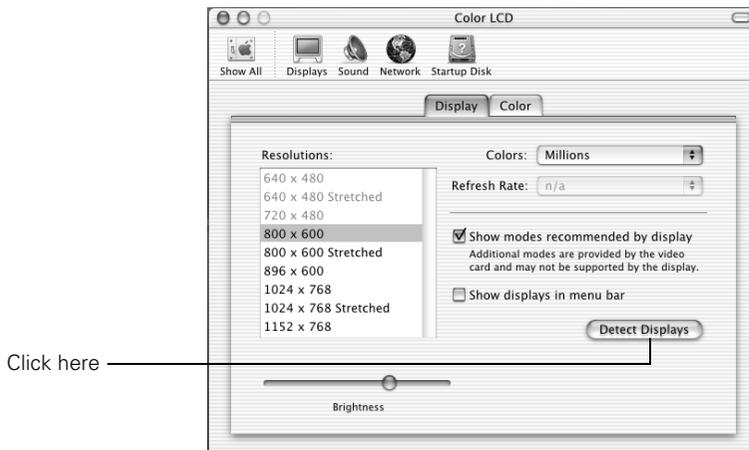

4. To display the entire desktop on both your projector screen and LCD screen, click the **Arrange** tab. (If you don't see this tab, check to see if there is a window hidden by another window on your screen.)

5. Click **Mirror Displays** in the lower corner of the screen. One of the monitor icons automatically moves on top of the other.

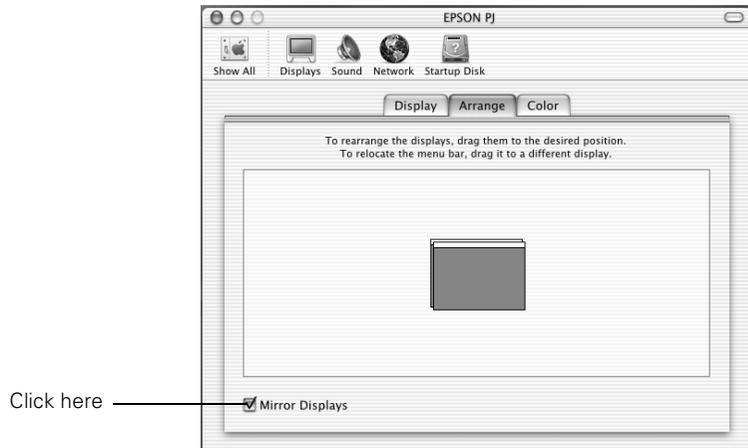

If You're Using a PC Laptop . . .

- Press the function key that lets you display on an external monitor. It's often labelled with an icon such as  but it may be labelled **CRT/LCD**. You may have to hold down the **Fn** key while pressing it. Check your laptop's manual or online help for details.

On most systems, the  or **CRT/LCD** key lets you toggle between the LCD screen and the projector, or display on both at the same time. Allow a few seconds for the projector to sync up after pressing it.

- Depending on your computer's video card, you might need to use the Display utility in the Control Panel to make sure that both the LCD screen and external monitor port are enabled. See your computer's documentation or online help for details.
- Check your computer's video resolution and scan frequency to see if they are supported, as listed on page 66. You may need to adjust your computer's resolution and scan frequency to match one of the modes listed.

Adjusting Your Image

Once you see your image, you'll need to make certain adjustments:

- To focus your image, see below.
- To resize or zoom into your image, see below.
- To raise or lower the image, see page 30.
- If the image isn't square, see page 31.
- If the projected image is flickering or "noisy," see page 32.

Focusing Your Image

Rotate the focus ring to sharpen the image.

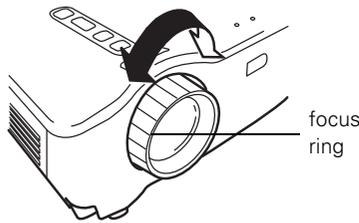

Adjusting the Image Size

You can adjust your image size using the Wide/Tele button on the projector or zoom into a portion of the image using the E-Zoom button on the remote control.

Using the Wide/Tele Button

To enlarge or reduce your image size in small increments, use the Wide/Tele button on the projector. Press the T side of the button to reduce the image size, or the W side of the Wide/Tele button to enlarge the image to full size.

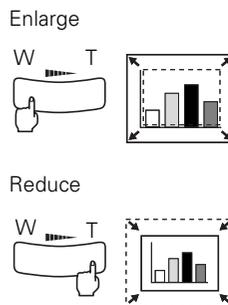
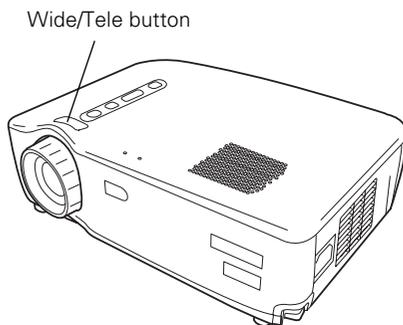

note

If the image from your computer is still out of focus, you can increase the clarity by pressing the Auto button on the remote control. This optimizes the projector's tracking, sync, and position settings. (You can also adjust these settings using the projector menus; see Chapter 3.)

note

You can always move the projector closer to or farther from the screen to adjust the image size.

Using the E-Zoom Button

If you want to zoom in on a portion of the image, use the E-Zoom and Enter buttons on the remote control. Press the + side of the E-Zoom button to zoom into your image in small increments. Press the – side to zoom out.

To position the zoomed image on the screen, press the top, bottom, left, or right side of the Enter button on the remote control. (Press Esc to return your image to its original size and turn off E-Zoom.)

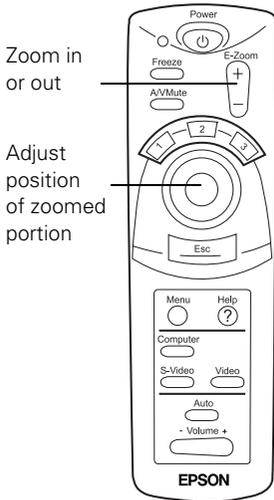

E-Zoom button

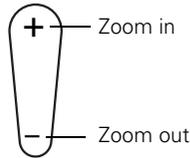

Enter button

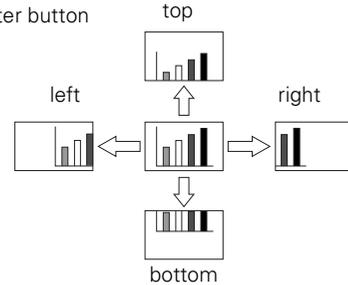

Adjusting the Image Height

If your image is too low, you can raise it by extending the projector's feet.

1. Stand behind the projector. Pull up the blue foot release levers and lift the front of the projector. This unlocks the feet.

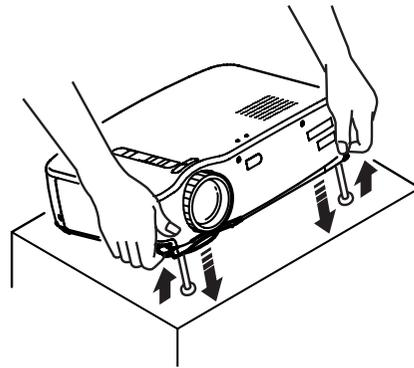

2. Raise or lower the front of the projector as necessary.

caution

To avoid damaging the lens, do not lift the projector by the lens.

3. Once the image is positioned where you want it, release the levers to lock the feet into position.
4. To fine-tune the height, rotate the feet clockwise to raise the projector and counterclockwise to lower it.

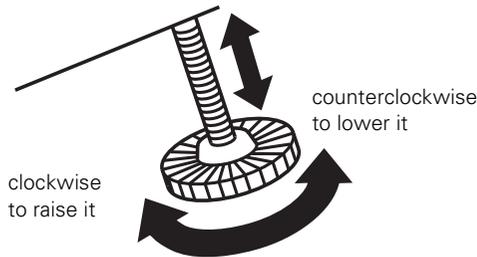

note

If the image shape is not square after adjusting its position, see the next section for a solution.

Adjusting the Image Shape

If the projected image isn't square or has a "keystone" shape, do one or more of the following:

- If your image looks like  or , you've placed the projector off to one side of the screen, at an angle. Move it directly in front of the center of the screen, facing the screen squarely.
- If your image looks like  or , press the + or - side of the **Keystone** button to correct the shape of the image. The **Keystone** button corrects up to a 15° tilt. After correction, your image will be slightly smaller.

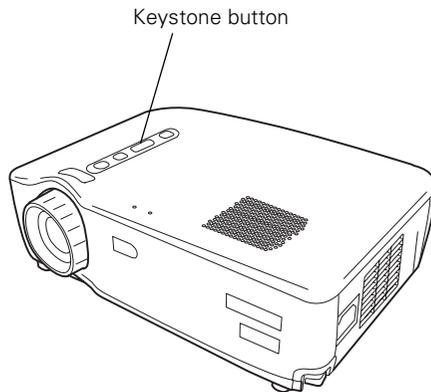

You can also perform electronic keystone correction using the projector's Setting menu. See page 44 for instructions.

note

If the image is noticeably uneven after keystone correction, reduce the Sharpness setting using the Video menu; see page 41 for instructions.

note

You can also increase computer image clarity by pressing the **Auto** button on the remote control to optimize the tracking, sync, and position settings. Turn off **E-Zoom** and **A/V Mute** before using the **Auto** button; see page 30 and page 36.

infrared receiver
for remote control

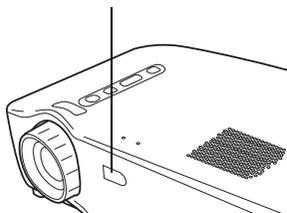

note

You can aim the remote control at your projection screen and reflect the signal back into the sensor on the front of the projector, but this shortens the operating distance of the remote control.

Adjusting the Image Quality

You may need to adjust the projector's Tracking and Sync settings if your computer image has any of these quality problems:

- Flashing or blurry image
- Vertical or horizontal stripes
- Only a portion of the image is displayed

See Chapter 3 for instructions on adjusting these settings in the projector's Video menu.

Using the Remote Control

The remote control lets you access projector features from anywhere in the room—up to 32 feet away. You must also be within a 30° horizontal and a 15° vertical angle of the infrared receiver on the front of the projector.

You can use the remote control to turn the projector on and off, zoom the image, display the projector menus, and other uses. If you connected a mouse cable to the projector, you can also use the remote control as a wireless mouse to run your presentation. See page 34 for instructions.

Installing the Remote Control Batteries

The remote control operates the projector and lets you access its setup menus. You can also use it as a wireless mouse.

Follow these steps to install the batteries:

1. Press the tab to release the battery cover and lift it up to remove it.

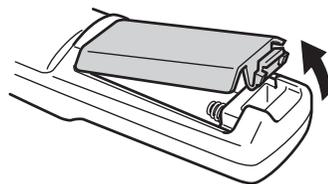

2. Insert the two AA batteries included with the projector as shown.

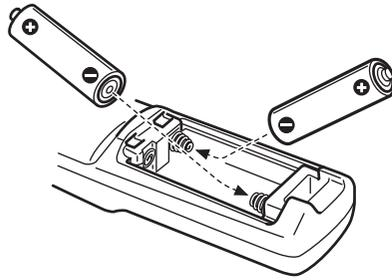

3. Replace the battery cover.

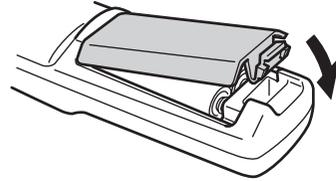

Operating the Projector with the Remote Control

1. Push up the R/C switch on the side of the remote control to turn it on.
2. Point the remote at the front of the projector or at the screen.
3. Press the button for the function you want to use. The light next to the **Power** button on the remote control flashes briefly. (If it doesn't flash, you may have inserted the batteries incorrectly or need to change the batteries; see page 32 for instructions.)

The projector may not respond to remote control commands in these conditions:

- You are too far away or not within a 30° horizontal or 15° vertical angle of the projector's sensor
- The R/C switch on the right side of the remote control is in the OFF position (the remote control is turned off)
- Batteries are weak
- Bright ambient light, fluorescent light, or direct sunlight is shining into the remote control sensor
- Equipment emitting infrared energy (such as a radiant room heater) is nearby and interfering with the sensor

caution

When replacing batteries, take the following precautions:

- Replace batteries as soon as they run out.
- Do not mix old and new batteries.
- If the batteries leak, wipe away battery fluid with a soft cloth. If fluid gets on your hands, wash them immediately.
- Remove batteries if you will not be using the remote for a long period of time.

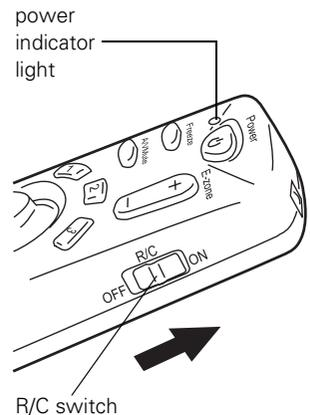

note

When you connect the mouse cable, your computer mouse is disabled and you can't use another external mouse with your desktop. However, you may still be able to use the built-in mouse pointer on your laptop.

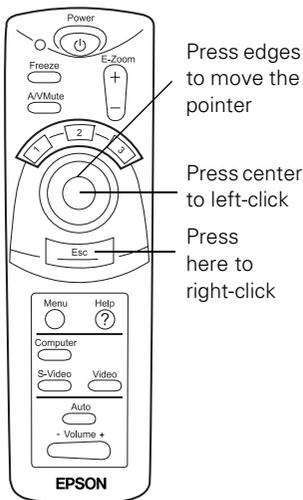

note

If you swapped the mouse button functions on your computer mouse, the Enter and Esc buttons on the remote control also swap functions.

Using the Remote Control as a Wireless Mouse

Using the remote control as a wireless mouse gives you more flexibility; you don't need to stay near your computer or the projector to run your presentation.

To use the remote control as a mouse, you must first connect a mouse cable between your computer and the projector. See Chapter 1 for instructions.

Follow these instructions to use your remote control as a wireless mouse:

- Aim the remote at the screen or at the receiver on the front of the projector. To move the mouse pointer on the screen, press the edges of the Enter button with your thumb, as you would to move a trackball.
- To click, press down on the center of the Enter button. To double-click, press down twice on the Enter button.
- To click and drag, press down on the Enter button and then tilt it in the direction you want to drag.
- To right-click, press the Esc button.
- To change slides in a PowerPoint® presentation (in Slide Show mode), press down on the Enter button.

Controlling Audio and Video

While giving your presentation, you may want to switch between picture sources, temporarily turn off or freeze the picture, or adjust the volume.

Make sure you've first set up your projector and connected your audio or video source as described in Chapter 1.

Switching Between Picture Sources

You can connect the projector simultaneously to one computer source and one video source. Then you can use the buttons on the projector or remote control to switch between them.

- Press the **Source** button on the projector to switch between computer, S-video, and composite video sources.
- Press the **Computer**, **Video**, or **S-Video** button on the remote control to select the source you want to use.

After you select a source, the screen goes dark for a moment before the image appears.

Freezing the Picture

You can use the remote control to freeze the current picture on the screen.

- Press the **Freeze** button to freeze the current image on the screen. The sound will continue.
- Press the **Freeze** button again to re-start it.



Select
Computer,
Video, or
S-Video

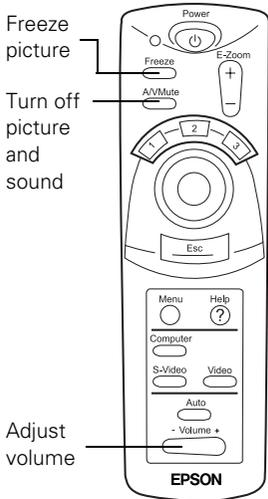

Turning Off the Picture and Sound

You can use the **A/V Mute** button on the remote control to turn off the image and sound. This lets you temporarily re-direct your audience's attention without the distraction of a bright screen.

- To turn off the picture, press the **A/V Mute** button. The screen goes dark.
- To turn the image back on, press the **A/V Mute** button again.

You can change the color of the blank screen displayed while **A/V Mute** is on using the Setting menu; see page 44 for instructions.

Adjusting Sound Volume

Using the remote control, you can adjust the volume of your video or computer sounds.

- To increase the volume, press on the right (+) side of the **Volume** button.
- To decrease the volume, press on the left (-) side of the **Volume** button.

Highlighting Your Presentation

The projector's highlighting tools let you emphasize areas on the screen using the numbered buttons on the remote control. This is useful for annotating your presentation slides or calling attention to their most important points. These tools are available:

- Arrow or cursor stamp (button 1)
- Horizontal bar (button 2)

You can use the Effect menu to customize the highlighting tools. See page 43 for instructions.

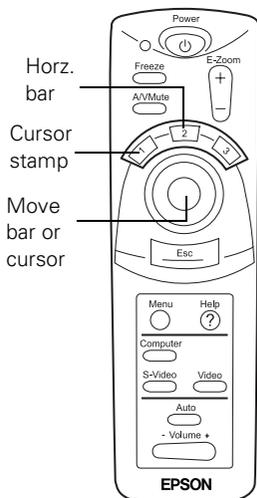

Using the Cursor/Stamp Arrow

You can use the cursor stamp tool as a pointer and place cursor stamps anywhere on your screen.

1. To activate the cursor stamp, press the **1** button on the remote control. A  icon appears on the screen.
2. Press the side of the **Enter** button to move the pointer wherever you want it.
3. To “paste” the pointer on the screen, press down in the center of the **Enter** button. You can then continue to move another pointer around the screen and paste it wherever you want.
4. To erase the pointers pasted on the screen, press the **3** button.
5. To cancel the cursor stamp feature, press the **Esc** button.

note

You can use the projector's Effect menu to select a different cursor stamp shape and size. See page 43 for instructions.

Drawing a Horizontal Bar

You can place a horizontal bar on the screen and move it up or down to highlight your presentation points.

1. To activate the bar tool, press the **2** button on the remote control. A magenta horizontal bar appears in the middle of the screen.
2. Press the top or bottom of the **Enter** button to move the bar up or down the screen.
3. To erase the bar from the screen, press the **Esc** button.

note

You can change the width and color of the bar using the projector's Effect menu. See page 43 for instructions.

Shutting Down the Projector

When you've finished using the projector, follow the recommended procedure to shut it down. This extends the life of the lamp and protects the projector from possible overheating.

note

If sleep mode is enabled and the projector has not received any input signals for 30 minutes, it automatically turns off the projector lamp and enters "sleep mode." This conserves electricity, cools the projector, and extends the life of the lamp. In sleep mode, the **Power** light is orange. If you are done using the projector, unplug the power cord. If you want to start projecting again, press the **Power** button on the projector or the remote control.

1. If you've connected a computer or laptop and it's displaying only through the projector, shut down the computer first; otherwise you won't be able to see your computer's display if you try turning it off after the projector.
2. Press the red **Power** button on top of the projector or on the remote control. You see a confirmation message. (If you don't want to turn it off, press any other button.)

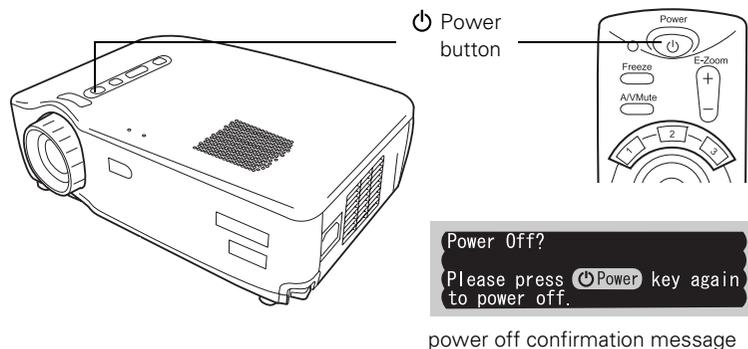

3. Press the **Power** button again. The **Power** light flashes orange for a couple of minutes as the projector cools down. When the projector has cooled, the orange **Power** light stays on and the fan shuts off.

If you want to turn the projector on again, wait until the orange **Power** light stops flashing. Then press the **Power** button.

4. Replace the lens cap, retract the projector feet, and unplug the power cord. Also turn off the remote control, if you were using it.
5. If you're using a VCR or other video source, turn it off after you turn off the projector.
6. Disconnect all equipment, and store the projector in a protective case.

caution

To avoid damaging the projector or lamp, never unplug the power cord when the **Power** light is green or flashing orange.

3 *Fine-Tuning the Projector*

You can use the on-screen menus to adjust the image, sound, and other features of your projector. This chapter covers the following information:

- Using the menus
- Adjusting the image
- Adjusting the sound
- Customizing the highlighting tools
- Customizing projector features
- Viewing projector information
- Restoring the default settings

Using the Menus

These on-screen menus let you adjust and customize the projector features from the remote control:

- **Video** controls the look and quality of the projected image (from a computer or video source).
- **Audio** adjusts the sound volume and tone.
- **Effect** customizes the highlighting tools available on the remote control.
- **Setting** adjusts features such as the keystone setting, blank screen color, message prompt, and sleep mode.
- **Advanced** controls settings such as menu language, color intensity, and rear or ceiling projection.

- **About** provides information about the current projector and lamp settings, and lets you reset the lamp timer when you've replaced the projector's lamp.
- **Reset All** restores the factory defaults to all the projector settings.

Changing Menu Settings

You use the **Menu**, **Enter** and **Esc** buttons on the remote control to change menu settings.

1. To display the main menu, press the **Menu** button. The menus are displayed on the left, and the options available for the current menu are shown on the right.

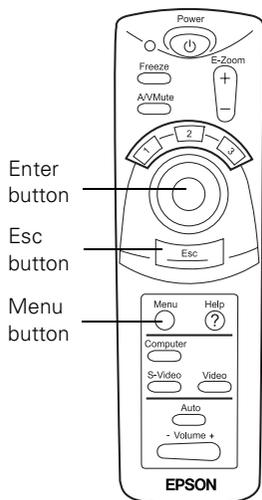

2. Press the top or bottom of the **Enter** button to scroll up or down through the menus and view the available options.
3. Press the center of the **Enter** button to select a menu. The highlight moves to the first menu option for that menu.
4. Press the bottom or the top of the **Enter** button to scroll through the options. Press the right or left side of the **Enter** button to change the setting.

If you want to go back to the default settings on any menu, select **Reset**, press **Enter**, select **Yes**, and then press **Enter**.

5. Press the **Esc** button to save your changes and go back to the main menu.
6. Press the **Menu** button to exit the menu system.

The rest of this chapter describes the menu options.

Adjusting the Image

You can make a variety of image adjustments with the Video menu. The options available in the menu depend on which source is connected to the projector: computer or video.

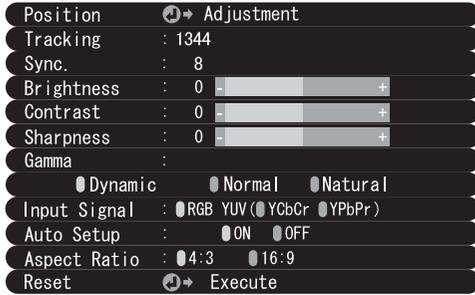

Computer or component video source menu

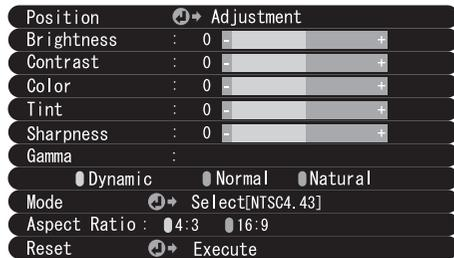

Video source menu

Video menu

| Menu item | Description |
|------------|---|
| Position | Moves the displayed image up, down, left, or right. Use the Enter button to move the screen position in the corresponding direction. |
| Tracking* | Removes vertical lines from the computer image by matching the projector's internal clock to various computer graphic signals. |
| Sync* | Corrects fuzziness or screen flicker by synchronizing the projector with the computer's tracking signal. Always adjust the Tracking before adjusting the Sync. |
| Brightness | Lightens or darkens the overall image. Increase brightness to lighten an image, or decrease it to darken the image. Press the right or left side of the Enter button to adjust the setting and see the results. |
| Contrast | Adjusts the difference between light and dark areas. Increase the contrast to make light areas lighter and dark areas darker. Decrease it to minimize the difference between light and dark areas. Press the right or left side of the Enter button to adjust the setting and see the results. |
| Color** | Adjusts the color depth of the video input source. Increase the color setting for more intense color on the screen, and lower the setting for less intense color. Press the right or left side of the Enter button to adjust the setting and see the results. |
| Tint** | Adjusts the tint of the video image colors. Increasing the Tint setting strengthens the red tint. Decreasing it strengthens the green tint. Press the right or left side of the Enter button to adjust the setting and see the results. |

Video menu

| Menu item | Description |
|-----------------|--|
| Sharpness | Adjusts the sharpness of the image. (If keystone correction adversely affects the image, decrease the Sharpness setting.) Press the right or left side of the Enter button to adjust the setting and see the results. |
| Gamma | Adjusts the vividness of image colors. Choose Dynamic for distinctly contrasted images, such as charts. Choose Normal to select medium contrast. Choose Natural to weaken contrast for more naturally colored images, such as photographs. |
| Input Signal* | Selects the input signal of your computer or component video equipment. Choose RGB for computer images. Choose YUV for component video images. Choose YCbCr for DVD images. Choose YPbPr for HDTV images. |
| Auto Setup* | Set to ON to have the projector automatically optimize the computer image for projection. |
| Mode** | Selects the video image signal mode: Automatic or Manual . (For PAL 60 Hz mode, set to Manual .) |
| Aspect Ratio*** | Selects the aspect ratio for YCbCr or YPbPr component video images. |
| Reset | Returns all Video menu settings to their factory defaults. |

* Available only when Computer is selected as the input source.

** Available only when Video is selected as the input source.

*** Available only when you're projecting component video images.

Adjusting the Sound

You can use the Audio menu to adjust the sound volume or quality.

Audio menu

| Menu item | Description |
|--------------|---|
| Volume | Adjusts the sound volume level output from the projector. Press the right or left side of the Enter button to adjust the setting. |
| Tone | Adjusts the sound quality by increasing or decreasing the treble. Press the right or left side of the Enter button to adjust the setting. |
| Audio Input* | Selects the audio input source. Select Auto to automatically choose the current video input source, or select Computer or Video exclusively. |
| Reset | Returns the Audio menu settings to their factory defaults. |

* For component video sources, select Video.

Customizing the Highlighting Tools

You can use the Effect menu to customize the highlighting tools, as described on page 36, and set the cursor speed.

Effect menu

| Menu item | Description |
|----------------|--|
| Cursor/Stamp | Selects the stamp you want to use as the cursor graphic and lets you enlarge it. |
| Horizontal Bar | Selects the color and width of the horizontal bar. |
| Cursor Speed | Adjusts the cursor speed to Low , Medium , or High . |
| Reset | Returns the Effect menu settings to their factory defaults. |

Customizing Projector Features

You can use the Setting menu and the Advanced menu to adjust a variety of projector functions.

Setting menu

| Menu item | Description |
|---------------|--|
| Keystone | Corrects a trapezoid-shaped, distorted image to a 4:3 ratio rectangle, adjusting up to a $\pm 15^\circ$ tilt. Press the right or left side of the Enter button to adjust the setting and see the results.* |
| No-Signal/Msg | Specifies whether no screen, a black screen, or a blue screen is projected when no video signals are received. |
| Prompt | Controls whether the projector displays a temporary message indicating the current input source (Computer or Video). |
| A/V Mute | Controls whether the projector displays a blue or black screen when the AVMute button is pressed. |
| Sleep Mode | Enables or disables sleep mode, which turns off your projector's lamp when it hasn't received any image signals for 30 minutes. Press the Power button on the projector or the remote control to resume projection. |
| Reset | Returns the Setting menu options to their factory defaults. |

* You can also use the Keystone button on the projector to adjust this setting. If the image is noticeably uneven, reduce the Sharpness setting on the Video menu.

Advanced menu

| Menu item | Description |
|---------------|---|
| Language | Selects the language the projector uses in the menus: English, French, German, Italian, Spanish, Portuguese, Japanese, Chinese, or Korean. |
| Color Setting | Selects the color temperature and RGB (red, green, blue) settings of the image. Increasing the color temperature creates cooler whites and decreasing it creates warmer whites. Increasing the RGB intensity strengthens the colors and decreasing it weakens the colors. |
| Rear Proj. | Mirrors the projected image on its left-right axis so it appears correctly when you're projecting from behind onto a transparent screen. |
| Ceiling | Flips the projected image on its top-bottom axis so it appears correctly when you mount the projector upside-down from the ceiling. |
| Reset | Returns the Advanced menu settings to their factory defaults. |

Viewing Projector Information

The About menu lets you view information about the display settings of your computer, your video signal mode, and the number of hours the lamp has been used. The options available in the menu depend on which source is connected to the projector: computer or video.

note

The life span of the projector lamp is approximately 1500 hours. If the number shown in the About menu is close to 1500, make sure you have a spare lamp handy. See page 6 for part number and ordering information.



Computer or component video source menu



Video source menu

About menu

| Menu item | Description |
|------------------|---|
| Lamp | Displays the number of hours the current lamp has been used. |
| Reset Lamp Timer | Sets the cumulative lamp time to zero; use this when you've replaced the projector lamp, as described on page 50. |
| Video Source | Displays the currently selected input source: Computer or Video . |
| Input Signal* | Displays the computer or component video input signal. |
| Frequency* | Displays the projector's horizontal and vertical frequency. |
| Sync Polarity* | Displays the computer's sync polarity. |
| Sync Mode* | Displays the computer's sync mode. |
| Resolution* | Displays the resolution of the computer's video output. |
| Refresh Rate* | Displays the refresh rate of the computer's video output. |
| Video Signal** | Displays the input image signal mode. |

* Available only when Computer is selected as the input source.

** Available only when Video is selected as the input source.

Restoring the Default Settings

The **Reset All** setting lets you return all the projector's menu settings to their initial factory defaults, except for the Lamp and Language settings.

Select **Reset All** and press the **Enter** button on the remote control to display the confirmation screen. Select **Yes** to reset all the default settings or **No** to cancel.

4 *Maintaining and Transporting the Projector*

warning

Before you clean any part of the projector, turn it off and unplug the power cord. Never open any cover on the projector, except the lamp cover. Dangerous electrical voltages in the projector can injure you severely. Do not try to service this product yourself, except as specifically explained in this User's Guide. Refer all other servicing to qualified service personnel.

Your projector needs little maintenance. All you need to do on a regular basis is keep the lens clean. Any dirt or smears on the lens will show up on your projected image.

You also need to periodically clean the air intake vent on the side of the projector. A clogged vent can block ventilation needed to cool the projector and keep it from overheating.

The only parts you should replace are the lamp and air intake vent (if necessary). If any other part needs replacing, contact your dealer or a qualified service person.

This chapter covers the following:

- Cleaning the lens
- Cleaning the projector case
- Cleaning the air intake vent
- Replacing the lamp
- Transporting the projector

Cleaning the Lens

Clean the lens whenever you notice dirt or dust on the surface.

- To remove dust, use a canister of compressed air to spray the lens surface, or lightly wipe the lens surface with a soft, dry, lint-free cloth.
- To remove dirt or smears, use lens-cleaning paper. If necessary, moisten a soft cloth with an alcohol-based cleaner and gently wipe the lens surface.

caution

Be careful not to get alcohol-based cleaner on the projector case.

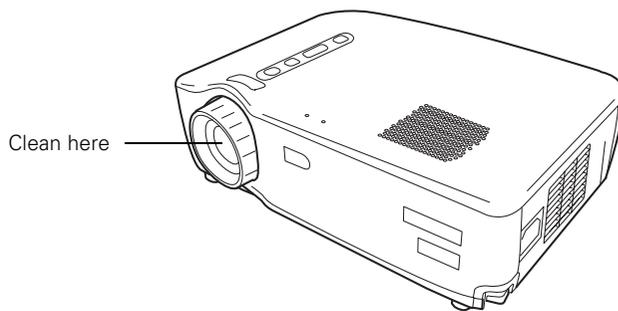

Cleaning the Projector Case

Before you clean the projector case, turn off the projector and unplug the power cord.

- To remove dirt or dust, wipe the outside with a soft, dry, lint-free cloth.
- To remove stubborn dirt or stains, clean the case using a soft cloth moistened with water and a neutral detergent. Dry it using a separate cloth.
- Do not use alcohol, benzene, thinner, wax, or other chemicals. These can damage the case.

Cleaning the Air Intake Vent

Clean the air intake vent after every 100 hours of use, or if the

 Error light on top of the projector turns red.

If the vent is not cleaned periodically, it can become clogged with dust, preventing proper ventilation. This can cause overheating and damage the projector. Follow these steps to clean the vent:

1. Turn off the projector, let it cool down, and unplug the power cord.
2. Stand the projector on its back panel with the lens pointing upward.

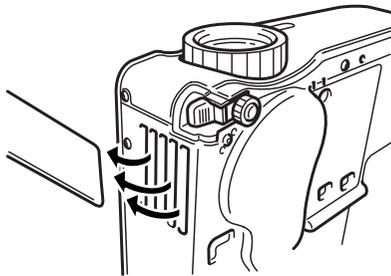

3. To clean the vent, EPSON recommends using a small vacuum cleaner designed for computers and other office equipment. If you don't have one, use a dry, lint-free cloth.

If the dirt is difficult to remove, replace the air intake vent. You can purchase the part from your dealer, or by calling EPSON at (800) 873-7766, or by visiting the EPSON Store at www.epsonstore.com (U. S. sales only). In Canada, please call (800) 463-7766 for dealer referral.

Replacing the Lamp

note

To view the number of hours your lamp has been used, check the About menu; see page 45 for details.

The projection lamp typically lasts for about 1500 hours of use. It is time to replace the lamp when:

- The projected image gets darker or starts to deteriorate.
- The  Error light on top of the projector is flashing red in 1-second intervals.
- The LAMP REPLACE message appears on the screen when the projector lamp comes on (after about 1400 hours of use). To maintain projector brightness and image quality, replace the lamp as soon as possible after you see the message.

To order a replacement lamp (part number V13H010L16), contact your dealer or call EPSON at (800) 873-7766 or visit the EPSON Store at www.epsonstore.com (U. S. sales only). In Canada, please call (800) 463-7766 for dealer referral.

Follow these steps to replace the lamp:

1. Turn off the projector, let it cool down, and unplug the power cord.
2. Allow the projector to continue cooling for at least one hour (if it has been on).
3. Turn the projector upside-down to access the lamp compartment.
4. To remove the lamp cover, press on the two tabs and pull out the cover.

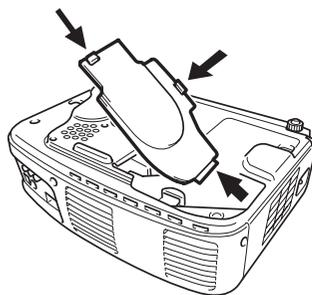

warning

Let the lamp cool before replacing it. To avoid premature lamp failure, do not touch the glass portion of the lamp assembly.

5. Use a screwdriver to loosen the two lamp cover screws; you can't remove the screws. Then pull out the lamp by the two notches.

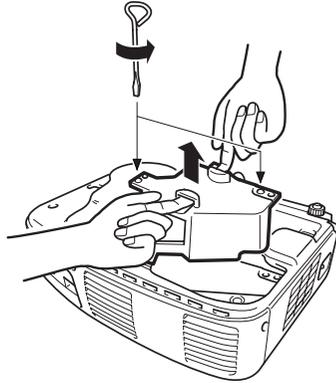

6. Position the new lamp correctly, then gently insert it into the projector. Press it into place and tighten the retaining screws.

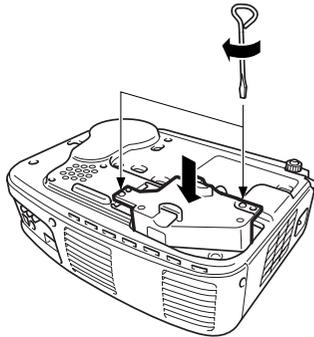

7. Insert the lamp cover as shown and press it back into place.

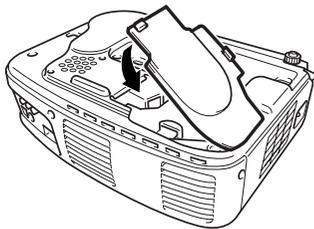

8. Follow the instructions in Chapter 3 to access the projector's About menu and reset the lamp counter to zero.

caution

Make sure the lamp cover is securely fastened; the  Error light flashes and the projector lamp won't turn on if the cover is open.

note

EPSON shall not be liable for any damage incurred during transportation.

Transporting the Projector

The projector contains many glass and precision parts. If you need to transport it, please follow these packing guidelines to prevent damaging the projector:

- When shipping the projector for repairs, use the original packaging material if possible. If you do not have the original packaging, use equivalent materials, placing plenty of cushioning around the projector.
- When transporting the projector as freight or checked luggage, first put it in a carrying case (such as an EPSON case), then pack it in a firm box, using cushioning around the case.
- When you're hand-carrying the projector, be sure to use a carrying case (such as an EPSON case).

5 *Solving Problems*

This chapter helps you diagnose and solve problems with your projector and provides technical support information for problems you can't solve yourself.

This chapter tells you how to:

- Use the projector's on-screen help system
- Check the projector's status using its lights
- Solve image or sound problems
- Solve remote control problems

If none of the suggestions here solve the problem, see “Where To Get Help” on page 60.

Using the On-Screen Help

If you have a problem while setting up or using your projector, you can get help by pressing the ? Help button on top of the projector or the remote control.

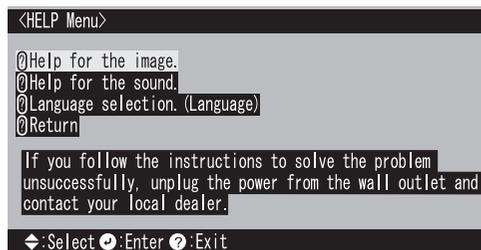

The following choices are available:

- **Help for the image**
Tells you how to solve problems with a blank screen, blurry images, brightness, colors, and image shape.
- **Help for the sound**
Provides help for problems with lack of audio.
- **Language Selection**
Lets you choose to display the help information and projector menus in any of 8 different languages.
- **Return**
Exits the help system.

Follow these steps to get help:

1. Press the **? Help** button. You see the main help menu.
2. To select the help menu you want, press the bottom or top of the **Select (Keystone)** button on the projector, or the bottom or top of the **Enter** button on the remote control.
3. Press the **Enter (Source)** button on the projector or the center of the **Enter** button on the remote control to select your help topic. Depending on the topic, you may see another menu or a list of solutions.
4. To exit the Help system, press the **? Help** button on top of the projector or the remote control.

If none of the Help menu choices solve your problem, see the solutions in the rest of this chapter.

Checking the Projector's Lights

If your projector isn't working correctly, first turn it off, wait for it to cool, and unplug it. Then plug the power cord back in and turn on the projector. If this doesn't solve the problem, check the lights on top of the projector. They alert you to problems with projector operations.

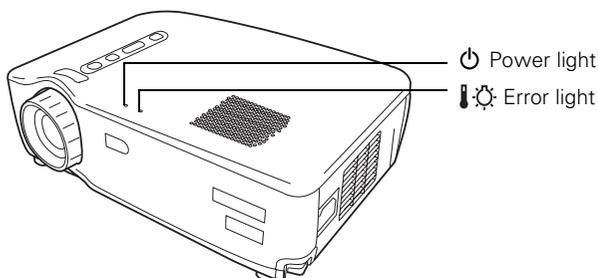

warning

Except as specifically explained in this User's Guide, do not attempt to service this product yourself.

| Light | Status | Description and action |
|-------|------------------------------------|--|
| | off | The projector is unplugged. Press the Power button to turn off the projector, check that the power cable is connected securely at both ends, then press the Power button again to turn on the projector. |
| | orange | The projector is in sleep mode. You can unplug it to disconnect the power or press the Power button to turn on the projector lamp. |
| | flashing green | The projector is warming up. Wait for the image to appear. |
| | green | The projector is operating normally. |
| | flashing orange | The projector lamp is off and the projector is cooling down. Wait until the light stops flashing and then press the Power button to turn on the projector. (You can't turn the projector on or unplug it when the light is flashing orange.) |
| | flashing red at 1-second intervals | The lamp cover is not closed securely or the lamp has burned out. Secure the lamp cover or replace the lamp; see page 50 for instructions. |
| | red | The projector is too hot. Turn it off and let it cool before using it. Also make sure nothing is blocking the projector's air intake vent. If it continues to overheat, clean the air intake vent; see page 49 for instructions. |
| | flashing orange | The projector lamp has turned off automatically because the projector has overheated. Let it cool for a few minutes, then turn it back on. Also make sure nothing is blocking the projector's air intake vent. If it continues to overheat, clean the air intake vent; see page 49 for instructions. |
| | flashing red at 2-second intervals | There is an internal problem with the projector. Unplug it from the electrical outlet and contact EPSON for help. |

Image or Sound Problems

No image appears or the No Signal message is displayed.

- Check that the  Power light is green and not flashing and the lens cover is off. If the  Power light is orange, the projector is in sleep mode; press the  Power button to wake it up.
- Your computer's screen saver may be on. Press a key on the computer keyboard.
- The A/VMute feature may be turned on. Press the A/VMute button on the remote control to turn it off, if necessary.
- Make sure the cables are connected correctly, as described in Chapter 1.
- Make sure the correct image source is selected. Press the Source button on top of the projector if necessary.
- Try restarting your computer. You may need to set the display to appear on both the LCD screen and the projector, or to switch between them. See the instructions beginning on page 26, or check your laptop documentation for instructions.

The Not Supported message is displayed.

The current video signal is not compatible with your projector. See page 66 for a list of compatible signals.

The image isn't square, but a trapezoid (keystone) shape.

This is caused by the projector not facing the screen squarely or by extending the projector's legs to position the image. Position the projector to face the screen squarely or press and hold the + or – side of the Keystone button on top of the projector until the image is squared-up.

Only part of the computer image is displayed.

- If the computer's output resolution setting is higher than 800 × 600 (EPSON PowerLite 51c) or 1024 × 768 (EPSON PowerLite 71c), the image is resized. If the computer output is not compatible with this resizing, choose a different display setting as follows:

Windows: In Windows 95/98/Me/2000/XP, right-click on the desktop, select **Properties**, click the **Settings** tab, and select the resolution you want. In Windows 3.x, use Windows Setup in the Main program group. See Windows help for more information.

PowerBook or Macintosh: For OS 9.x or earlier, choose **Control Panels** under the Apple menu and then choose **Monitors**. In the Monitors screen, choose **Options** and select **Macintosh Hi-Res Display** or another 800 × 600 (for the EPSON PowerLite 51c) or 1024 × 768 (for the EPSON PowerLite 71c) setting. For OS X, select **System Preferences** from the Apple menu, and then click **Displays**. In the VGA Display screen, choose an 800 × 600 (for the EPSON PowerLite 51c) or 1024 × 768 (for the EPSON PowerLite 71c) setting. For more information, see your PowerBook documentation. For supported display settings, see page 66.

- You may need to modify existing presentation files if you created them for a different resolution. See your software manual for specific information.

The image or parts of it are blurred or out of focus.

- Adjust the **Brightness**, **Contrast**, **Sharpness**, and/or **Gamma** settings on the **Video** menu. If you're viewing a computer image, also try adjusting the **Tracking** and **Sync** settings. See page 41 for instructions on using the menu.

When you change video settings, you should be able to see the effect on the screen immediately. Feel free to experiment. You can always select **Reset** to return to the factory default settings.

- There may be dirt or smears on the lens. Clean the lens by gently wiping it with an alcohol-based cleaner on a soft cloth. See page 48 for more information.
- Your video signal mode may not be detected automatically. Select **Manual** and then choose the correct signal for the Mode setting on the projector's Video menu; see page 41 for instructions.

The image vibrates, flickers, or has vertical lines.

- Adjust the Tracking and Sync settings on the Video menu (or through the projector's Help system). It is best to project a full screen containing black text on a white background (such as a letter) when you adjust these settings. Hold down the button to change the setting until your image looks correct. See page 41 for instructions on using the Video menu.
- It may not be possible to detect your video signal mode automatically. Select **Manual** and then choose the correct signal for the Mode setting on the projector's Video menu; see page 41 for instructions.

The image quality is poor on a laptop computer.

The video signal may be split between the computer and the projector. Try turning off the laptop LCD display. See your laptop manual or on-screen help for instructions.

The colors of the image are not right.

- If you're displaying video, adjust the Brightness, Contrast, Color, Tint, and/or Gamma settings on the Video menu. See page 41 for instructions.
- If you're displaying computer images, adjust the Brightness, Contrast, and/or Gamma settings on the Video menu. See page 41 for instructions. Also adjust the color temperature and RGB settings using the Color Setting option on the Advanced menu, as described on page 44. If necessary, you can also adjust your computer display settings to correct the color balance.

- Check the current lamp life and replace the lamp, if necessary. See page 45 for instructions on checking the lamp usage using the projector's About menu and page 50 for instructions on replacing the lamp.

There is no sound.

- Press the right side of the **Volume** button on the remote control to turn up the sound.
- Press the **A/VMute** button on the remote control to make sure this feature is not enabled.
- Make sure the right source is selected. Press the **Source** button on top of the projector to select the right source.
- Make sure the volume on your computer or video source is not turned all the way down or muted. See your Windows or Macintosh online help for instructions. Also, make sure the cables are connected correctly, as described in Chapter 1.
- Make sure the correct Audio Input signal is selected on the projector's Audio menu; see page 43 for instructions.

Problems with the Remote Control

The projector doesn't respond to remote control commands.

- Make sure the remote control is turned on.
- The remote control batteries may be low on power or inserted incorrectly. Check or replace them following the instructions on page 32.
- Dim the room lights, turn off any fluorescent lights, and move the projector away from direct sunlight. Strong lighting, especially fluorescent lights, may affect the projector's infrared receiver.
- Turn off any nearby equipment that emits infrared energy, such as a radiant room heater.

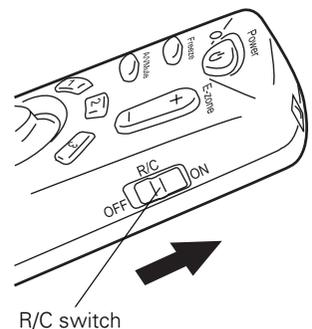

- Make sure you are within 32 feet of the projector and within a 30° horizontal or 15° vertical angle of the infrared receiver on the front of the projector.
- If you're having trouble using the remote control as a wireless mouse, make sure the mouse cable is securely connected to both ends. See Chapter 1 for details.

Where To Get Help

EPSON provides technical assistance through electronic support services, as listed in the following table:

| Service | Access |
|-------------------------------------|--|
| World Wide Web Technical Support | From the Internet, you can reach EPSON's product support page at http://support.epson.com . After selecting your product, you can view frequently asked questions and answers, download product documentation, and receive technical advice through e-mail. |
| Presenters Online | Access tips, templates, and training for developing successful presentations at http://www.presentersonline.com |

To use the EPSON PrivateLine Support service, call (800) 637-7661 and enter the PIN on the EPSON PrivateLine Support card included in your *Owner's Kit*. This is the fastest way to speak to a live representative, and it's free. This service is available 6 AM to 6 PM, Pacific Time, Monday through Friday, for the duration of your warranty period.

note

You can purchase screens, carrying cases, or other accessories from EPSON by calling (800) 873-7766, or visit the EPSON Store at www.epsonstore.com (U.S. sales only). In Canada, please call (800) 463-7766 for dealer referral.

You may also speak to a projector support specialist by dialing one of these numbers (toll or long distance charges may apply):

- U.S.: (562) 276-4394, 6 AM to 6 PM, Pacific Time, Monday through Friday
- Canada: (905) 709-3839, 6 AM to 6 PM, Pacific Time, Monday through Friday

Before you call, please have the following information ready:

- Product name (EPSON PowerLite 51c or 71c)
- Product serial number (located on the bottom of the projector)
- Video source (computer, DVD player, etc.) and how it's connected
- Description of the problem

6 *Technical Specifications*

General

| | |
|-------------------------------------|--|
| Type of display | Poly-silicon Thin Film Transistor (TFT) |
| Size of liquid crystal panels | Diagonal: 0.7 inch (17.8 mm) |
| Lens | F=1.5, f=26.3 mm |
| Focus adjustment | Manual |
| Zoom ratio | Digital 0.8 to 1.0, lens at maximum size, 100% to 83% (smallest) |
| Resolution | 51c: 800 × 600 pixels 71c: 1024 × 768 pixels |
| Color reproduction | 24 bit, 16.7 million colors |
| Brightness (ANSI) | 51c: 1200 lumens 71c: 1000 lumens |
| Image size (diagonal) | 2.3 to 25 ft (0.7 to 7.6 m) |
| Projection distance | 3.3 to 36 ft (1 to 11 m) in Wide mode 3.9 to 43.2 ft (1.2 to 13.1 m) in Tele mode |
| Projection methods | Front, rear, upside-down (ceiling mount) |
| Internal speaker system | 1W monaural |
| Optical aspect ratio | 4:3 (horizontal:vertical), adjustable to 16:9 for HDTV, NTSC, PAL, and SECAM images |
| Keystone correction angle | ±15° |
| Supported video interface standards | NTSC, NTSC4.43, PAL, PAL-M, PAL-N, PAL60, SECAM, HDTV |
| EPSON Control Code | ESC/VP Level 5 |

Projection Lamp

| | |
|-------------------|-----------------------------|
| Type | UHE (Ultra High Efficiency) |
| Power consumption | 160 W |
| Lamp life | About 1500 hours |
| Part number | V13H010L16 |

Remote Control

| | |
|-----------|-----------------------|
| Range | 32.8 feet (10 meters) |
| Batteries | Alkaline AA (2) |

Mouse Compatibility

Supports PS/2, USB, and ADB

Dimensions

| | |
|--------|----------------------|
| Height | 3.14 inches (80 mm) |
| Width | 11.8 inches (300 mm) |
| Depth | 8.66 inches (220 mm) |
| Weight | 6.8 lb (3.1 kg) |

Electrical

| | |
|-------------------|--|
| Rated frequency | 50/60 Hz |
| Power supply | 100 to 120 VAC, 2.4 A 200 to 240 VAC, 1.2 A |
| Power consumption | Operating: 240 W Sleep mode: 8.6 W |

Environmental

| | |
|---------------------------------|--|
| Temperature (non-condensing) | Operating: 41 to 95 °F (5 to 35 °C), Storage: 14 to 140 °F (-10 to 60 °C) |
| Humidity (non-condensing) | Operating: 20 to 80% RH Storage: 10 to 90% RH |

Safety

| | |
|---------------|---|
| United States | FCC Part 15J Class B UL1950 Rev. 3 |
| Canada | DOC SOR/88-475 CSA C22.2 No. 950 Rev. 3 |
| CE Marking | Directive 89/336/EEC EN 55022 Class B EN 50082-1 Directive 73/23/EEC EN 60950 |

Computer Connector Pin Assignments

The Computer port is a female video RGB, 15-pin micro-D-style connector.

| Input pin | Computer connector signals |
|------------------|-----------------------------------|
| 1 | Red video |
| 2 | Green video |
| 3 | Blue video |
| 4 | GND |
| 5 | GND |
| 6 | Red video GND |
| 7 | Green video GND |
| 8 | Blue video GND |
| 9 | Reserve |
| 10 | Synchronous GND |
| 11 | GND |
| 12 | SDA |
| 13 | Horizontal sync/composite sync |
| 14 | Vertical sync |
| 15 | SCL |

Compatible Video Formats

The projector supports the video formats listed below. To project computer images, the computer's video card must be set at a refresh rate (vertical frequency) that's compatible with the projector.

| Mode | Resolution | Frequency | | | 51c | 71c |
|---------------------------|-------------|-----------|--------|-------------|-------------|--------------|
| | | H (KHz) | V (Hz) | Pixel (MHz) | | |
| PC (RGB) compatible modes | | | | | | |
| VGACGA | 640 x 400 | 31.46 | 70 | 25.175 | 800 x 500 * | 1024 x 640 * |
| VGAEGA | 640 x 350 | 31.46 | 70 | 25.175 | 800 x 437 * | 1024 x 560 * |
| VGA60 | 640 x 480 | 31.469 | 59.94 | 25.175 | 800 x 600 * | 1024 x 768 * |
| VGA72 | 640 x 480 | 37.861 | 72.809 | 31.5 | 800 x 600 * | 1024 x 768 * |
| VGA75 | 640 x 480 | 37.5 | 75 | 31.5 | 800 x 600 * | 1024 x 768 * |
| VGA85 | 640 x 480 | 48.269 | 85.008 | 36 | 800 x 600 * | 1024 x 768 * |
| VGA Text | 720 x 350 | 31.469 | 70.087 | 28.322 | 800 x 388 * | 1024 x 568 * |
| VGA Text | 720 x 400 | 31.469 | 70.087 | 28.322 | 800 x 444 * | 1024 x 497 * |
| SVGA56 | 800 x 600 | 35.156 | 56.25 | 36 | 800 x 600 | 1024 x 768 * |
| SVGA60 | 800 x 600 | 37.879 | 60.317 | 40 | 800 x 600 | 1024 x 768 * |
| SVGA72 | 800 x 600 | 48.077 | 72.188 | 50 | 800 x 600 | 1024 x 768 * |
| SVGA75 | 800 x 600 | 46.875 | 75 | 49.5 | 800 x 600 | 1024 x 768 * |
| SVGA85 | 800 x 600 | 53.674 | 85.061 | 56.25 | 800 x 600 | 1024 x 768 * |
| XGA43i | 1024 x 768 | 35.522 | 86.958 | 44.9 | 800 x 600 * | 1024 x 768 |
| XGA60 | 1024 x 768 | 48.363 | 60.004 | 65 | 800 x 600 * | 1024 x 768 |
| XGA70 | 1024 x 768 | 56.476 | 70.069 | 75 | 800 x 600 * | 1024 x 768 |
| XGA75 | 1024 x 768 | 60.023 | 75.029 | 78.75 | 800 x 600 * | 1024 x 768 |
| XGA85 | 1024 x 768 | 68.677 | 84.997 | 94.5 | 800 x 600 * | 1024 x 768 |
| SXGA1-70 | 1152 x 864 | 63.851 | 70.012 | 94.5 | — | 1024 x 768 * |
| SXGA1-75 | 1152 x 864 | 67.5 | 75 | 108 | — | 1024 x 768 * |
| SXGA1-85 | 1152 x 864 | 77.094 | 84.999 | 121.5 | — | 1024 x 768 * |
| SXGA2-60 | 1280 x 960 | 60 | 60 | 108 | — | 1024 x 768 * |
| SXGA2-75 | 1280 x 960 | 75 | 75 | 126 | — | 1024 x 768 * |
| SXGA2-85 | 1280 x 960 | 85.938 | 85.002 | 148.5 | — | 1024 x 768 * |
| SXGA3-43i | 1280 x 1024 | 46.433 | 86.871 | 78.75 | — | 960 x 768* |
| SXGA3-60 | 1280 x 1024 | 63.981 | 60.02 | 108 | — | 960 x 768* |
| SXGA3-75 | 1280 x 1024 | 79.976 | 75.025 | 135 | — | 960 x 768* |
| SXGA3-85 | 1280 x 1024 | 91.146 | 85.024 | 157.5 | — | 960 x 768* |
| VESA60 | 640 x 480 | 31.469 | 59.941 | 25.175 | 800 x 600 | 1024 x 768 |
| VESA72 | 640 x 480 | 37.861 | 72.809 | 31.5 | 800 x 600 | 1024 x 768 |
| VESA75 | 640 x 480 | 37.5 | 75 | 31.5 | 800 x 600 | 1024 x 768 |
| VESA85 | 640 x 480 | 43.269 | 85.008 | 36 | 800 x 600 | 1024 x 768 |

| Mode | Resolution | Frequency | | | 51c | 71c |
|--|-------------|-----------|--------|-------------|-------------|--------------|
| | | H (KHz) | V (Hz) | Pixel (MHz) | | |
| PC (RGB) compatible modes (continued) | | | | | | |
| MAC II 13 | 640 x 480 | 35 | 66.67 | 30.24 | 800 x 600 * | 1024 x 768 * |
| MAC16 | 832 x 624 | 49.107 | 75.087 | 55 | 800 x 600 * | 1024 x 768 * |
| MAC19-60 | 1024 x 768 | 48.193 | 59.28 | 64 | 800 x 600 * | 1024 x 768 |
| MAC19-75 | 1024 x 768 | 60.241 | 74.93 | 80 | 800 x 600 * | 1024 x 768 |
| MAC21 | 1152 x 870 | 68.682 | 75.062 | 100 | 800 x 600 * | 1024 x 768 * |
| PC (YUV) compatible modes | | | | | | |
| HDTV525I (D1) ** | 640 x 480 | 15.734 | 59.94 | 13.5 | 800 x 600 * | 1024 x 768 * |
| HDTV525P (D2) ** | 640 x 480 | 31.469 | 59.94 | 27 | 800 x 600 * | 1024 x 768 * |
| HDTV750P (D4) ** | 1280 x 720 | 45 | 60 | 74.25 | 800 x 450 * | 1024 x 576 * |
| HDTV1125I (D3) ** | 1920 x 1080 | 33.75 | 60 | 74.25 | 800 x 450 * | 1024 x 576 * |
| HDTV1125I (D3) ** | 1920 x 1080 | 31.25 | 50.04 | 74.25 | 800 x 450 * | 1024 x 576 * |
| Video compatible modes | | | | | | |
| NTSC ** | 640 x 480 | 15.734 | 60 | — | 800 x 600 * | 1024 x 768 * |
| PAL ** | 720 x 540 | 15.625 | 50 | — | 800 x 600 * | 1024 x 768 * |
| SECAM ** | 720 x 540 | 15.625 | 50 | — | 800 x 600 * | 1024 x 768 * |

* Resize mode (all others native mode)

** Select 4:3 or 16:9 mode as the Aspect Ratio setting in the Video menu; see page 42 for instructions.

7

Notices

This chapter includes safety instructions and other important information about your EPSON PowerLite.

Important Safety Instructions

Follow these safety instructions when setting up and using the projector:

- Do not place the projector on an unstable cart, stand, or table.
- Do not use the projector near water or sources of heat.
- Use attachments only as recommended.
- Use the type of power source indicated on the projector. If you are not sure of the power available, consult your dealer or power company.
- Place the projector near a wall outlet where the plug can be easily unplugged.

Placez le projecteur près d'une prise de contact où la fiche peut être débranchée facilement.

- Insert the projector's three-wire grounding-type plug into a properly grounded outlet. If you have a two-prong outlet, contact an electrician to replace it. Do not hold the plug with wet hands.
- Take the following precautions for the plug. Failure to comply with these precautions could result in sparks or fire: Do not insert the plug into an outlet with dust present. Insert the plug firmly into the outlet.
- Do not overload wall outlets, extension cords, or integral convenience receptacles. This can cause fire or electric shock.

- Do not place the projector where the cord can be walked on. This may result in fraying or damage to the plug.
- Unplug the projector from the wall outlet before cleaning. Use a damp cloth for cleaning. Do not use liquid or aerosol cleaners.
- Do not block the slots and openings in the projector case. They provide ventilation and prevent the projector from overheating. Do not operate the projector on a sofa, rug, or other soft surface, or in a closed-in cabinet unless proper ventilation is provided.
- Never push objects of any kind through cabinet slots. Never spill liquid of any kind into the projector.
- Except as specifically explained in this *User's Guide*, do not attempt to service this product yourself. Refer all servicing to qualified service personnel. Opening or removing covers may expose you to dangerous voltages and other hazards.
- Unplug the projector during lightning storms or when it will not be used for extended periods.
- Do not place the projector and remote control on top of heat-producing equipment or in a hot location.
- Unplug the projector from the wall outlet and refer servicing to qualified service personnel under the following conditions: When the power cord or plug is damaged or frayed. If liquid has been spilled into the projector, or if it has been exposed to rain or water. If it does not operate normally when you follow the operating instructions, or if it exhibits a distinct change in performance, indicating a need for service. If it has been dropped or the housing has been damaged.
- If you use the projector in a country other than where you purchased it, use the correct power cable for that country.

Remote Control Information

You can operate the projector by remote control via a line-of-sight infrared (IR) receiver at the front of the projector. The projector may not respond to remote control commands under the following conditions:

- There is an object between the remote control IR emitter and the IR receiver on the projector.
- Ambient light is too bright.
- Certain types of fluorescent lighting are used.
- A strong light source shines into the IR receiver.
- Other equipment that emits infrared energy, such as a radiant room heater, is in the room.

These conditions commonly cause problems for most infrared-controlled equipment. Try the following:

- The remote control unit's batteries may be low on power; replace them.
- Dim the ambient lighting and/or turn off any fluorescent lights.
- Close any window coverings and/or move the projector out of direct sunlight.
- Turn off other equipment that emits infrared energy.

If the remote control still does not work properly, remember you can always control your computer-based presentation directly from the computer, even in an environment containing one of the conditions listed above.

Declaration of Conformity

According to 47CFR, Part 2 and 15

Class B Personal Computers and Peripherals; and/or
CPU Boards and Power Supplies used with Class B
Personal Computers

We: EPSON AMERICA, INC.
Located at: 3840 Kilroy Airport Way
MS: 3-13
Long Beach, CA 90806-2469
Tel: (562) 290-5254

Declare under sole responsibility that the product identified herein, complies with 47CFR Part 2 and 15 of the FCC rules as a Class B digital device. Each product marketed, is identical to the representative unit tested and found to be compliant with the standards. Records maintained continue to reflect the equipment being produced can be expected to be within the variation accepted, due to quantity production and testing on a statistical basis as required by 47CFR §2.909. Operation is subject to the following two conditions: (1) this device may not cause harmful interference, and (2) this device must accept any interference received, including interference that may cause undesired operation.

Trade Name: EPSON
Type of Product: LCD Projector
Model: EMP-51/71

FCC Compliance Statement

For United States Users

This equipment has been tested and found to comply with the limits for a Class B digital device, pursuant to Part 15 of the FCC Rules. These limits are designed to provide reasonable protection against harmful interference in a residential installation. This equipment generates, uses, and can radiate radio frequency energy and, if not installed and used in accordance with the instructions, may cause harmful interference to radio or television reception. However, there is no guarantee that interference will not occur in a particular installation. If this equipment does cause interference to radio and television reception, which can be determined by turning the equipment off and on, the user is encouraged to try to correct the interference by one or more of the following measures:

- Reorient or relocate the receiving antenna.
- Increase the separation between the equipment and receiver.
- Connect the equipment into an outlet on a circuit different from that to which the receiver is connected.
- Consult the dealer or an experienced radio/TV technician for help.

WARNING

The connection of a non-shielded equipment interface cable to this equipment will invalidate the FCC Certification of this device and may cause interference levels which exceed the limits established by the FCC for this equipment. It is the responsibility of the user to obtain and use a shielded equipment interface cable with this device. If this equipment has more than one interface connector, do not leave cables connected to unused interfaces. Changes or modifications not expressly approved by the manufacturer could void the user's authority to operate the equipment.

For Canadian Users

This Class B digital apparatus meets all requirements of the Canadian Interference-Causing Equipment Regulations.

Cet appareil numérique de la classe B respecte toutes les exigences du Règlement sur le matériel brouilleur du Canada.

Warranty

Epson America, Inc. Limited Warranty

Basic Two-Year Warranty and 90-Day Lamp Warranty

What Is Covered: Epson America, Inc. (“EPSON”) warrants to the first end user customer of the EPSON product enclosed with this limited warranty statement that the product, if purchased and used in the United States or Canada, conforms to the manufacturer’s specifications and will be free from defects in workmanship and materials for a period of two (2) years from the date of original purchase (except that the warranty period is 90 days for projector lamps).

What EPSON Will Do To Correct Problems: If you elect carry-in warranty service, please bring the product securely packaged in its original container or an equivalent, along with proof of the date of original purchase, to your EPSON Dealer or EPSON Customer Care Center. EPSON will, at its option, repair or replace on an exchange basis the defective unit, without charge for parts or labor. When warranty service involves the exchange of the product or of a part, the item replaced becomes EPSON property. The exchanged product or part may be new or previously repaired to the EPSON standard of quality. Exchange or replacement products or parts assume the remaining warranty period of the product covered by this limited warranty. However, each replacement lamp carries the limited 90-day warranty stated above.

What This Warranty Does Not Cover: This warranty covers only normal consumer use in the United States and Canada. For lamps, 24-hour-per-day use causes unusual strain and is not considered normal use. This warranty does not cover consumables (e.g., fuses), other than lamps. EPSON is not responsible for warranty service should the EPSON label or logo or the rating label or serial number be removed or should the product fail to be properly maintained or fail to function properly as a result of misuse, abuse, improper installation, neglect, improper shipping, damage caused by disasters such as fire, flood, and lightning, improper electrical current, software problems, interaction with non-EPSON products, or service other than by an EPSON Authorized Servicer. Postage, insurance, or shipping costs incurred in presenting your EPSON product for carry-in warranty service are your responsibility. If a claimed defect cannot be identified or reproduced in service, you will be held responsible for costs incurred.

THE WARRANTY AND REMEDY PROVIDED ABOVE ARE EXCLUSIVE AND IN LIEU OF ALL OTHER EXPRESS OR IMPLIED WARRANTIES INCLUDING, BUT NOT LIMITED TO, THE IMPLIED WARRANTIES OF MERCHANTABILITY OR FITNESS

FOR A PARTICULAR PURPOSE. SOME LAWS DO NOT ALLOW THE EXCLUSION OF IMPLIED WARRANTIES. IF THESE LAWS APPLY, THEN ALL EXPRESS AND IMPLIED WARRANTIES ARE LIMITED TO THE WARRANTY PERIOD IDENTIFIED ABOVE. UNLESS STATED HEREIN, ANY STATEMENTS OR REPRESENTATIONS MADE BY ANY OTHER PERSON OR FIRM ARE VOID. EXCEPT AS PROVIDED IN THIS WRITTEN WARRANTY, NEITHER EPSON AMERICA, INC. NOR ITS AFFILIATES SHALL BE LIABLE FOR ANY LOSS, INCONVENIENCE, OR DAMAGE, INCLUDING DIRECT, SPECIAL, INCIDENTAL OR CONSEQUENTIAL DAMAGES, RESULTING FROM THE USE OR INABILITY TO USE THE EPSON PRODUCT, WHETHER RESULTING FROM BREACH OF WARRANTY OR ANY OTHER LEGAL THEORY. IF THE REMEDY ABOVE FAILS, EPSON'S ENTIRE LIABILITY SHALL BE LIMITED TO A REFUND OF THE PRICE PAID FOR THE EPSON PRODUCTS COVERED BY THIS LIMITED WARRANTY.

In Canada, warranties include both warranties and conditions.

Some jurisdictions do not allow limitations on how long an implied warranty lasts and some jurisdictions do not allow the exclusion or limitation of incidental or consequential damages, so the above limitations and exclusions may not apply to you.

This warranty gives you specific legal rights, and you may also have other rights, which vary from jurisdiction to jurisdiction.

To locate the Authorized EPSON Servicer nearest you, call the EPSON ConnectionSM at (800) 637-7661 + PIN or (562) 276-4394 in the U.S. and (905) 709-3839 in Canada or write to: Epson America, Inc., P.O. Box 93012, Long Beach, CA 90809-3012.

Index

A

- A/V cable, 18 to 20
- A/V Mute screen color setting, 44
- A/V Mute button, 36, 56, 59
- About menu, 45
- Accessories, 6 to 7, 60
- Adobe Acrobat Reader, 2 to 3
- Advanced menu, 44
- Air intake vent, cleaning, 49
- Arrow tool, 37
- Aspect Ratio setting, 42
- Audio
 - adjusting tone, 43
 - adjusting volume, 36, 43
 - cable, 11, 13, 15, 17
 - cable, stereo, 21
 - menu, 43
 - problems, 59
- Audio Out jack, 21
- Auto button, 29, 32
- Auto Setup setting, 42

B

- Bar tool, 37, 43
- Bass, adjusting sound, 43
- Batteries, remote control, 32
- Blank screen, 25 to 28
- Blurry image, 32, 57 to 58
- Brightness setting, 41

C

- Cable
 - A/V, 18 to 20
 - audio, 11, 13, 15, 17
 - computer, 10, 12, 14 to 16
 - mouse, 11, 13, 15, 17
- Camcorder, connecting, 18 to 20
- Case, cleaning, 48
- CE Marking, 65

Ceiling, hanging projector from, 6, 8, 44

- Cleaning
 - air intake vent, 49
 - lens, 48
 - projector, 48

- Color
 - problems, 58
 - setting, 41

Color temperature setting, 44

Component video, connecting, 19 to 20

- Computer
 - button, 25, 35
 - cable, 10, 12, 14 to 16
 - connecting Macintosh desktop, 16 to 18
 - connecting PC desktop, 12 to 13
 - connecting PC laptop, 10 to 12
 - connecting PowerBook, 14 to 15
 - connector pin assignments, 65

Connections, choosing, 9

Contrast setting, 41

Cursor Speed setting, 43

Cursor/Stamp tool, 37, 43

D

Declaration of Conformity, 72

Default settings, restoring, 46

Desktop PC, connecting, 12 to 13

Digital camera, connecting, 18 to 20

Dimensions, 64

Distance from projector to screen, 7 to 8

DVD player, connecting, 18 to 20

E

Effect menu, 43

Electrical specifications, 64

E-mail support, 60

Enter button, 30, 34, 40

Environmental specifications, 64

EPSON

- accessories, 6 to 7, 60
 - PrivateLine Support, 1, 3 to 4, 60
 - Store, 7
 - technical support, 4, 60 to 61
- Error light, 49, 51, 55
- Esc button, 30, 34, 37, 40
- External speakers, connecting, 21
- E-Zoom button, 30

F

- FCC statement, 73
- Focusing image, 29, 57 to 58
- Foot release levers, 30
- Freeze button, 35

G

- Gamma setting, 42

H

- HDTV, connecting, 18 to 20
- Help button, 53 to 54
- Help system, using, 53 to 54
- Help, EPSON *see* EPSON
- Highlighting presentation, 36, 43
- Horizontal bar tool, 37, 43
- Humidity requirements, 64

I

Image

- adjusting, 29 to 31, 41 to 42
 - blurry, 57 to 58
 - correcting shape, 56
 - focusing, 29, 57 to 58
 - height, adjusting, 30
 - help, 53 to 54
 - positioning, 30 to 31, 41
 - problems, 56 to 59
 - quality, 32
 - raising, 30
 - shape, adjusting, 31
 - size and distance from screen, 7 to 8
 - size range, 63
 - size, adjusting, 29
 - turning off, 36
 - zooming, 30
- Input Signal setting, 42
- Internet, 60

K

- Keystone
- button, 31, 56
 - setting, 44

L

Lamp

- number of hours used, 45
 - replacing, 50 to 51
 - reset timer setting, 45
 - specifications, 64
- Language setting, 44, 54
- Laptop PC
- connecting, 10 to 12
 - displaying on, 28
- Laser disc player, connecting, 18 to 20
- Lens cleaning, 48
- Lights, status and warning, 55
- Locating projector, 7 to 8
- Lumens, 1, 63

M

Macintosh

- desktop, connecting, 16 to 18
- mouse cable, 15, 17
- PowerBook, connecting, 14 to 15

Manuals, 2 to 4

Menu button, 40

Menus

- About, 45
- Advanced, 44
- Audio, 43
- Effect, 43
- Reset All, 46
- Setting, 44
- using, 39 to 40
- Video, 41 to 42

Mode setting, 42

Mouse cable, 11, 13, 15, 17

N

No Signal message, 25, 44, 56

Numbered buttons on remote control, 36

O

Options for the projector, 6 to 7

P

PA system, connecting, 21

Picture, *see* Image

Pin assignments, connector, 65

Positioning

- image, 30 to 31, 41
- projector, 7 to 8

Power

- button, 24, 33, 38
- consumption, 64
- light, 24 to 25, 38, 55
- management, 44
- supply, 64

PowerBook

- connecting, 14 to 15
- displaying on, 26

Presenters Online, 3, 60

PrivateLine Support, 1, 3 to 4, 60

Problems, *see* Troubleshooting

Projector

- choosing connections, 9
- cleaning, 48
- connecting to Macintosh desktop, 16 to 18
- connecting to PC desktop, 12 to 13
- connecting to PC laptop, 10 to 12
- connecting to PowerBook, 14 to 15
- connecting to video source, 18 to 20
- distance from screen, 7 to 8
- feet, 30
- focusing, 29
- hanging from the ceiling, 44
- lamp specifications, 64
- lights, 55
- menu system, using, 39 to 40
- options, 6 to 7
- positioning, 7 to 8
- positioning image, 41
- problems, 55 to 60
- shutting off, 38
- software, 4
- specifications, 63 to 67
- status lights, 55
- transporting, 52
- turning on, 23 to 24
- unpacking, 5
- viewing information, 45

Prompt setting, 44

PS/2 mouse cable/port, 11, 13

R

Raising image, 30

RCA A/V cable, 18 to 20

Rear projection, 44

Registration, 4

Remote control
connecting cable for wireless mouse, 11, 13, 15, 17
information, 71
installing batteries, 32
problems, 33, 59 to 60, 71
specifications, 64
turning on, 33
using, 32 to 34, 40
using as wireless mouse, 34

Replacing the lamp, 50 to 51

Reset All menu, 46

Reset Lamp Timer setting, 45

Resetting menu options, 40

Resizing
images, 29
problems, 57

Resolution
pixels, 1
PowerBook, selecting, 26
problems, 57
specifications, 63

S

Safety instructions, 47, 69 to 70

Screen, distance from projector, 7 to 8

Select button, 54

Setting menu, 44

Sharpness setting, 42

Shutting off projector, 38

SizeWise technology, 1

Sleep mode, 24, 38, 44

Software, 4

Sound
adjusting, 36, 43
help, 53 to 54
problems, 59
turning off, 36

Sound system, connecting, 21

Source, selecting, 25, 35

Speakers, connecting to, 21

Specifications
dimensions, 64
electrical, 64
environmental, 64
general, 63
lamp, 64
remote control, 64
safety, 65

Stamp tool, 37, 43

Status lights, 55

Stereo audio cable, 21

Stopping action, 35

Support, 4, 60 to 61

S-Video, 6, 19, 25, 35

Sync, 32, 41, 57 to 58

T

Technical support, 4, 60 to 61

Temperature
requirements, 64
warning light, 55

Tint setting, 41

Tone setting, 43

Tracking, 32, 41, 57

Transporting the projector, 52

Trapezoid image, 56

Treble, adjusting sound, 43

Troubleshooting
color problems, 58
image and sound problems, 56 to 59
projector problems, 55 to 60
remote control problems, 59 to 60

Turning off projector, 38

Turning on projector, 23 to 24

U

Unpacking projector, 5

USB mouse cable/port, 11, 13, 15, 17

V

VCR, connecting, 18 to 20

Video

button, 25, 35

display settings, viewing, 45

menu, 41 to 42

problems, 56 to 59

source, connecting, 18 to 20

source, selecting, 25, 35

Volume

button, 36

setting, 43

W

Warning lights, 55

Warranty, 4, 74 to 75

Wide/Tele button, 29

Wireless mouse, using remote control as, 34

World Wide Web, 60

Z

Zoom ratio, 63

Zooming image, 30